

JSR Series

High Purity Bio-Pharma Gas Pressure Reducing Valves

JSR is the first high purity gas pressure regulator designed and built specifically for hygienic, ASME BPE gas applications.

Traditionally, manufacturers adapted their industrial gas regulators for use in biopharm by simply changing the construction materials and surface finish. Not so with the JSR. It's been designed specifically to eliminate the exposed threaded connections and permanent contaminant traps below the diaphragm. And, it features an in-line removable trim set to facilitate quick trim change out and cleaning without valve removal or disassembly.

The durable valve body and metal trim components are machined from ASTM A479 316L SST barstock and finished to ASME BPE SF5 (20Ra micro-inch, electropolished) standard. The valve is outfitted with the rugged Jorlon diaphragm and Teflon, PEEK, or EPDM seats and seals that are all FDA approved, USP Class VI compliant materials. These materials of construction enable JSR to withstand the rigors of SIP and CIP processes if required. And, the new EPDM seat reduces lockup to less than 2.5 psig.

FEATURES

- No exposed threaded connections below diaphragm
- In-line removable seat and trim facilitate cleaning and maintenance
- Barstock construction guarantees material integrity and surface finish
- High flow rate coupled with high rangeability reduces need for reduced trim sizes
- Minimized internal volume
- Proprietary Jorlon diaphragm material provides exceptionally long life and CIP/SIP capability
- Soft seat material for ANSI Class VI shutoff
- New EPDM seat for low lockup and tight shutoff on no flow or deadhead blanketing applications

DOCUMENTATION AND TRACEABILITY

The following documentation is shipped at no charge:

- Steriflow Unicert, a QC signed Certificate of Compliance for:
 - Material, listing heat numbers with attached MTR's
 - Surface Finish
 - FDA/USP Class VI - for all thermoplastic and elastomers
- Traceability:
 - Each individual product serial number is traceable to the Unicert serial number, heat numbers and attached MTR's

Other documents must be requested at time of RFQ, or order:

- ADI/TSE Free, Certified Test reports, Certificate of Origin.

New!

- Air Augment Option
- EPDM seat for low lockup and tight shutoff



APPLICATIONS

Ideal for clean gases typically found in bio-pharmaceutical, pharmaceutical and food & beverage processes including:

- Clean Filter Air
- Nitrogen
- Carbon Dioxide
- Argon
- Oxygen
- Custom purge or blanket gas

NOTE: Though not drainable in any installation orientation, this valve can be used on clean steam or non-cavitating liquids with Steriflow engineering application approval.

CRN Registration Number Available

SPECIFICATIONS

Sizes: 1/2" (DN15) & 3/4" (DN20)

End Connections: ASME BPE, DIN, ISO Tri-clamp, or Tube Weld end; NPT

Gauge Ports: 1/4" FNPT is standard. Contact Factory for Tri-Clamp, VCR, or other alternatives.

Soft Seat Materials for ANSI Class VI Shut-Off:

- PTFE to +252°F (122°C) continuous or 275°F (135°C) intermittent [not to exceed 15 min. in a one hour period] FDA, USP Class VI
- PEEK to +350°F (176,7°C) FDA, USP Class VI
- EPDM to +275°F (135°C) FDA, USP Class VI*
* Suggested for low lockup and tight shutoff on no flow or deadhead blanketing applications.

Body Material: ASME SA479 316L (UNS 31603) is standard. EN 10272:2000 GR 1.4435, AL-6XN®, Hastelloy®C-22 and others are optional.

Diaphragm Material: PTFE-based Jorlon FDA, USP Class VI

Maximum Inlet Pressure: 150 psig (10,5 bar)

Optional Cleaning Specifications

- Clean for Oil-Free
- O2 Cleaning complying with ASTM G93-03 2011 and CGA G-4.1-2009

Spring Ranges: 5–70 psi (0,3–4,8 bar); 15-90 psi (0,1–6,2 bar); 50–125 psi (3,4–8,6 bar)

Flow Capacity - Cv (Kv)

- High Flow: Trim Cv 0.8 (Kv 0,7)
- Low Flow: Trim Cv 0.5 (Kv 0,43)

Failure - Cv (Kv)

- High Flow: Cv 0.96 (Kv 0,83)
- Low Flow: Cv 0.6 (Kv 5,2)

Surface Finish:

- Wetted Internal surface finish: Mechanically polished, and electropolished to ASME BPE SF5, 20 Ra µin (0.5 Ra µm) as standard
- Exterior surface finish: Mechanically polished, and electropolished to 40 Ra µin (1.0 Ra µm) as standard,
- Other finishes available upon request

Options:

- Panel Mounting
- Captured Vent
- Self Relieving
- Air Augment

Note: For a complete ancillary list of all wetted and non-wetted material specifications, please contact Steriflow Valve.

OPTION DEFINITION

Captured Venting

The captured vent option provides a means to vent downstream, self-relieved gas. To enable this function, a 1/8" FNPT collar is installed on the spring housing. This feature provides a means to safely transport toxic or hazardous, self-relieved downstream gas away from the spring housing via tubing to a safe area.

!VIP! This option must be specified with the Self-Relieving* option if the user wishes to transport self-relieved vented gas to a safe location.

Air Augment

The air augment option provides a means for air loading the valve spring housing for automated control. To enable this function a 1/8" FNPT collar is installed on the spring housing (the same one used for the captured vent option), and a Teflon seal nut is included to seal the adjusting screw threads to prevent leakage. The 1/8" FNPT port is used as the input fitting for loading the spring housing with instrument air to completely automate or augment manual regulator control. An I/P transducer, or a small, self-relieving air set PRV regulator is required (ordered separately) to regulate the instrument air pressure.

***Self-Relieving**

The self-relieving option provides an internal mechanism to vent downstream pressure increase (above the set-point) through the spring housing and out a vent hole in the spring housing. If the gas is toxic, or dangerous - the Captured-Vent option (above) must also be specified. The Self-Relieving option allows for immediate pressure reduction when reducing the set point, provides a means to automatically relieve downstream pressure build-up when flow stops and the valve starts to close (sometimes called Lock-up), and alleviates pressure equalization across the orifice when the regulator is not operating.

!VIP! If selecting the Self-relieving option for a Toxic or Hazardous gas - the Captured Vent option must be selected. You cannot Air-Load if the Self-Relieving option is specified.

Panel Mount

The panel mounted regulator option illustrated on the next page requires a panel cut out of 1-1/2". When this option is specified, the regulator comes fitted with a threaded spring housing, and a panel mounting ring to secure the regulator to the panel.

Gauge Ports - Pressure Gauge

For inlet and outlet pressure gauges (and the gauges) are available as standard options

OPTION ILLUSTRATIONS

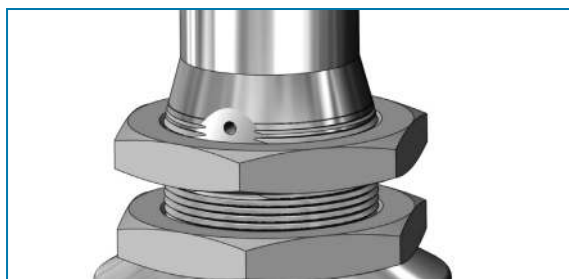

Panel Mount Option

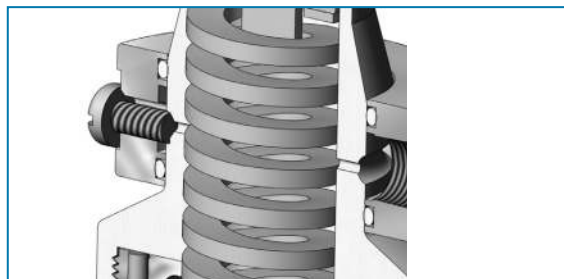

Captured Vent Option (1/8" NPT)

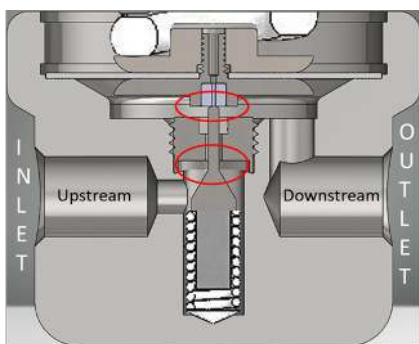

Figure 1: Self Relieving Valve in Closed Position when P2 = set point and flow stops

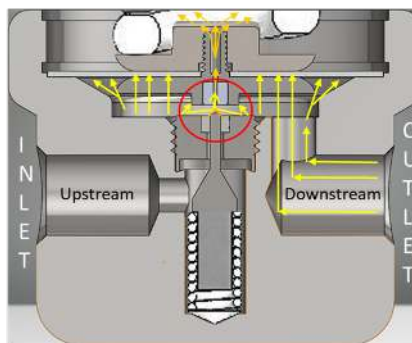
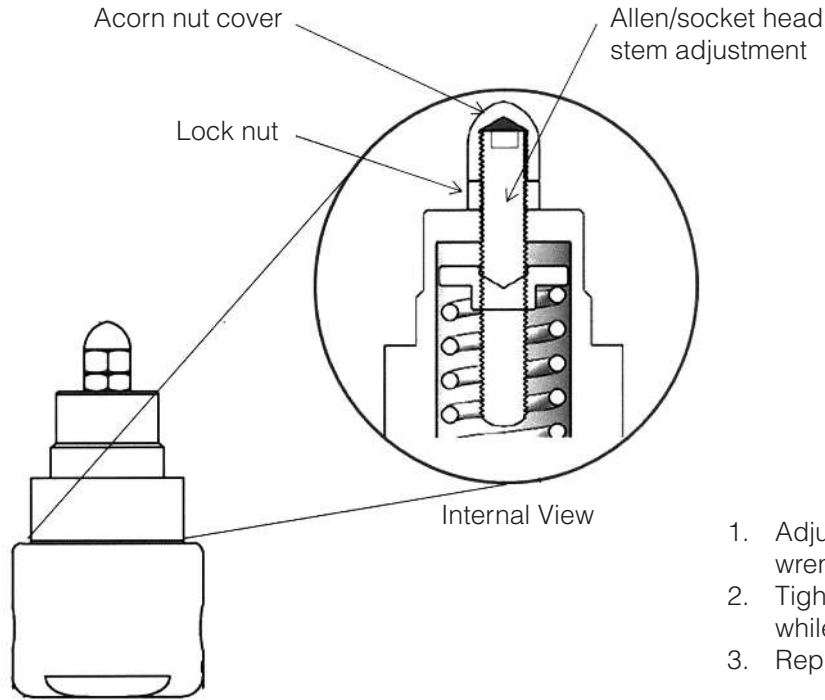

Figure 2: Self Relieving Valve in Closed Position when flow stops and P2 > set point. Showing overpressure release.

Concept illustration of Self-Relieving Option

ANTI-TAMPER OPTION



1. Adjust stem position with Allen wrench
2. Tighten lock nut against bonnet while holding stem position
3. Replace and tighten acorn nut

DIN & ISO TRI-CLAMP DIMENSIONS

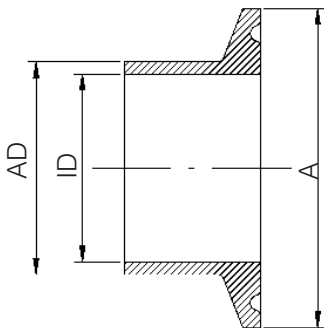

DIN 32676 Row B (ISO 1127)

VALVE SIZE	A	AD	ID
DN15	50.5	21.3	18.1
DN15*	34.0	21.3	18.1
DN20	50.5	26.9	23.7

* with non-standard Tri-clamp face

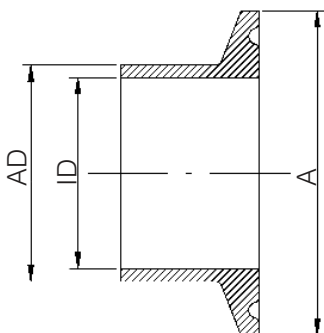

DIN 32676 Row A (DIN 11850)

VALVE SIZE	A	AD	ID
DN15	34.0	19.0	16.0
DN15*	50.5	19.0	16.0
DN20	34.0	23.0	20.0
DN20*	50.5	23.0	20.0

* with non-standard Tri-clamp face

FLOW CONFIGURATIONS/ GAUGE PORTS

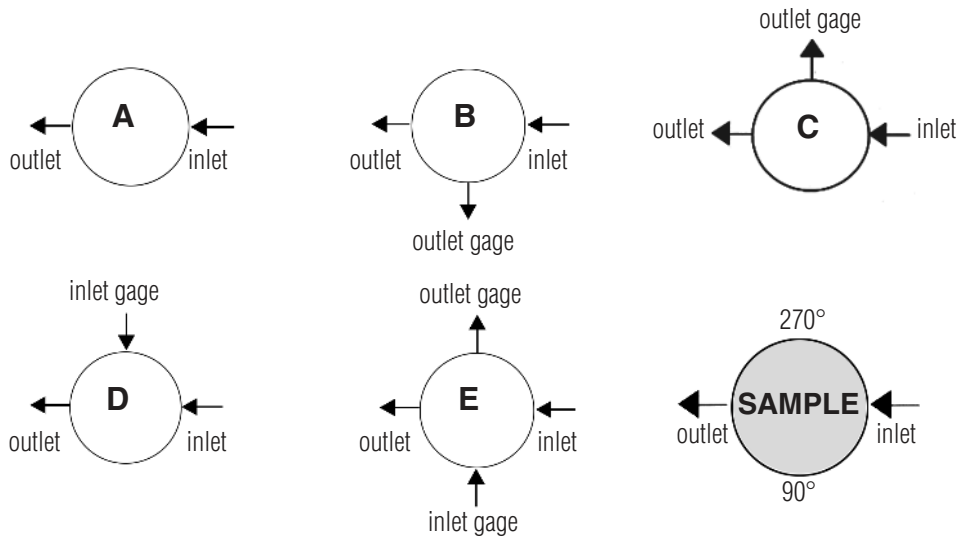

* Gage ports are 1/4" FNPT as standard. Other porting options are available at www.steriflowvalve.com under the resources tab

DIMENSIONS, IN. (MM)

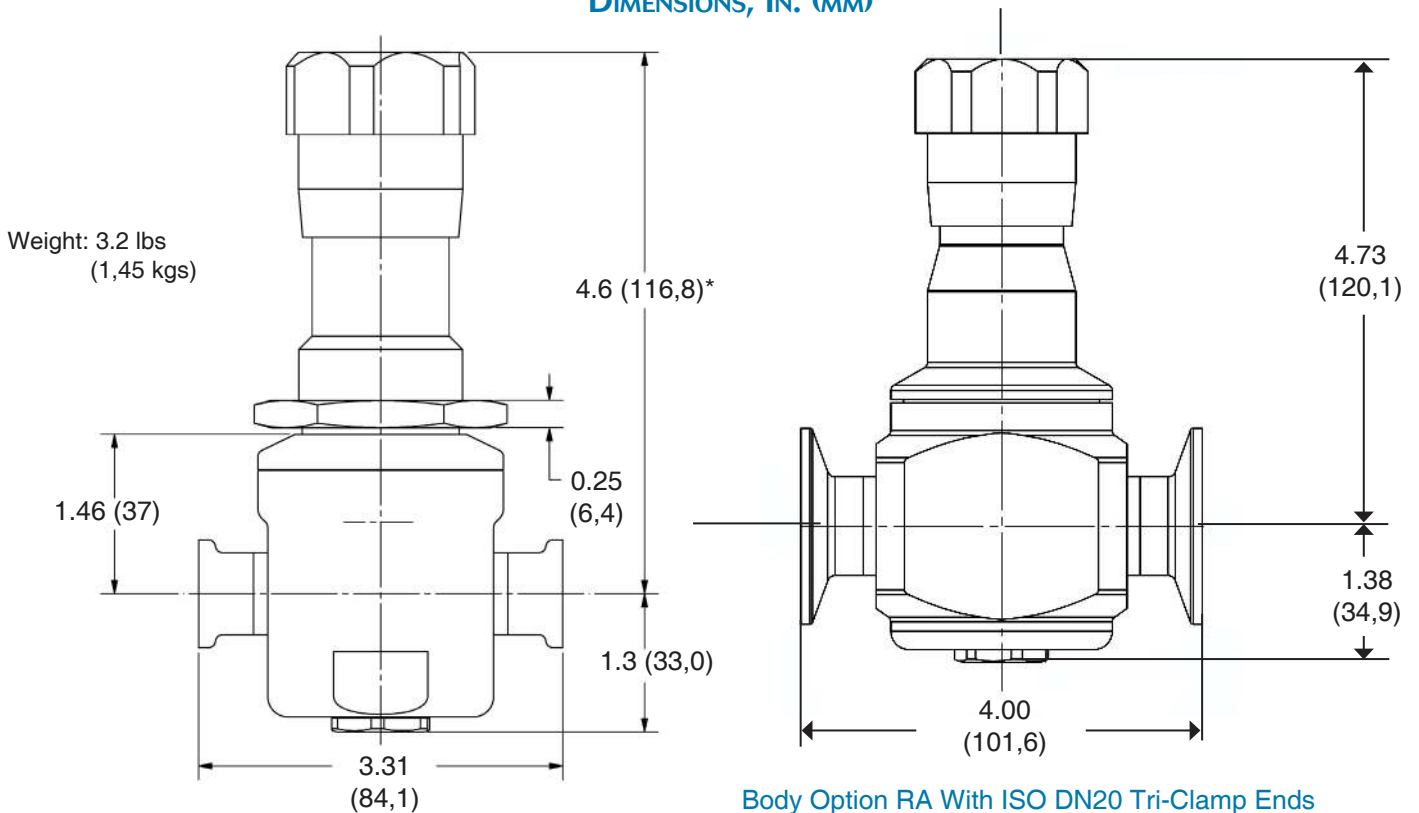

SAMPLE SPECIFICATIONS

Stainless Steel pressure regulator shall be made from ASTM A479 barstock material, which includes body and all wetted metal parts. Regulator shall be activated by an un-tied, FDA approved, USP Class VI certified Jorlon diaphragm. Regulator shall be free of exposed threads within wetted process area and valve internal to hold minimal media volume. Regulator shall have trim that can be replaced inline without dome/spring chamber disassembly.

FEATURES & BENEFITS

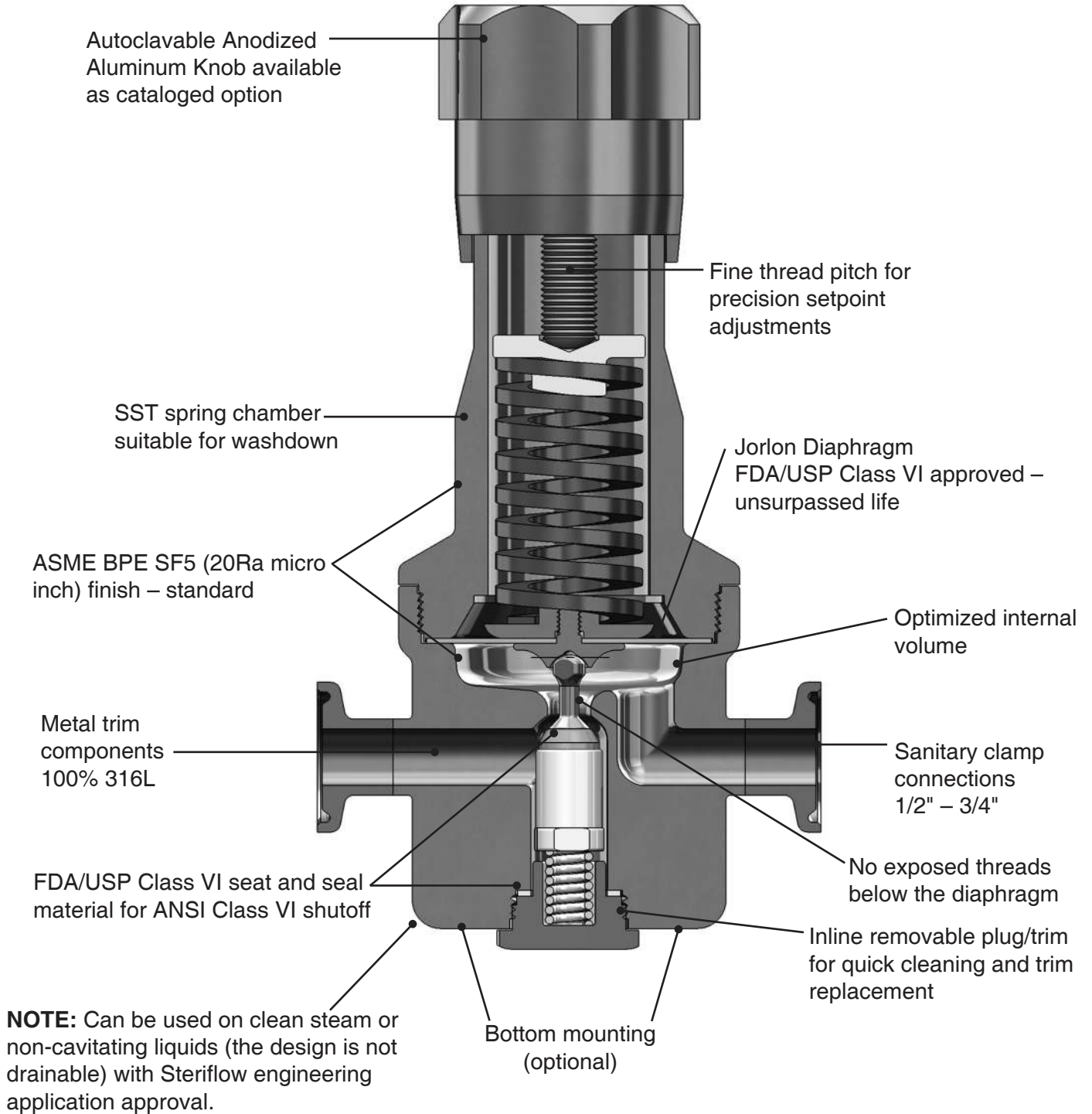

CV TRIM SELECTION INSTRUCTIONS

To select a valve with the proper Cv:

1. Select a graph on the following 21 pages that best represents your outlet pressure set point and flow range
2. Looking at that graph, select the closest inlet pressure line (horizontal sloped line, P1) that best reflects your application's actual inlet pressure. That line indicates the Pressure/Flow capabilities and offset (droop) of the trim (Flow Coefficient, Cv) under flowing conditions.

Note: If your exact outlet pressure set point or inlet pressure is not listed you will have to interpolate.

- Your particular inlet pressure line will be very similar in length and slope to the line chosen on any particular graph.
 - The same is true for your outlet pressure set point, simply shift the line up or down.
3. The Cv and range spring are listed in bold at the upper left of the page of your chosen graph. You will need that for model number selection (See page 30).

GAS CONVERSION FACTORS

The following sizing charts for the JSR were derived using Nitrogen as the flow medium at ambient conditions. In order to convert your gas to the equivalent volume of Nitrogen, multiply your application's flow by the appropriate multiplying factor below.

GAS	Specific Gravity	Multiplying Factor
Air	1	1.02
Ammonia	0.596	0.79
Argon	1.379	1.19
Arsine	2.695	1.67
CO	0.967	1
CO2	1.529	1.26
Ethylene	0.975	1

GAS	Specific Gravity	Multiplying Factor
Helium	0.138	0.38
Hydrogen	0.07	0.27
Methane	0.555	0.76
Natural Gas	0.555	0.76
Nitrogen	0.967	1
Oxygen	1.105	1.07
Propane	0.495	0.72

For all other gaseous media, use the following formula to calculate the appropriate multiplying factor.

(Sg = Specific Gravity of the media)

$$\frac{1}{\sqrt{\frac{0.967}{Sg(\text{any gas})}}}$$

FLOW DATA FOR CV TRIM SELECTION

The graphs illustrate the change or "droop" in outlet pressures as the flow rate increases, and the lockup (setpoint rise) as flow decreases and approaches zero.

Flow Coefficient: 0.5

Range Spring: 5 - 70 psig (0,34 - 4,8 bar)

Maximum inlet pressure: 150 psig (10,3 bar)

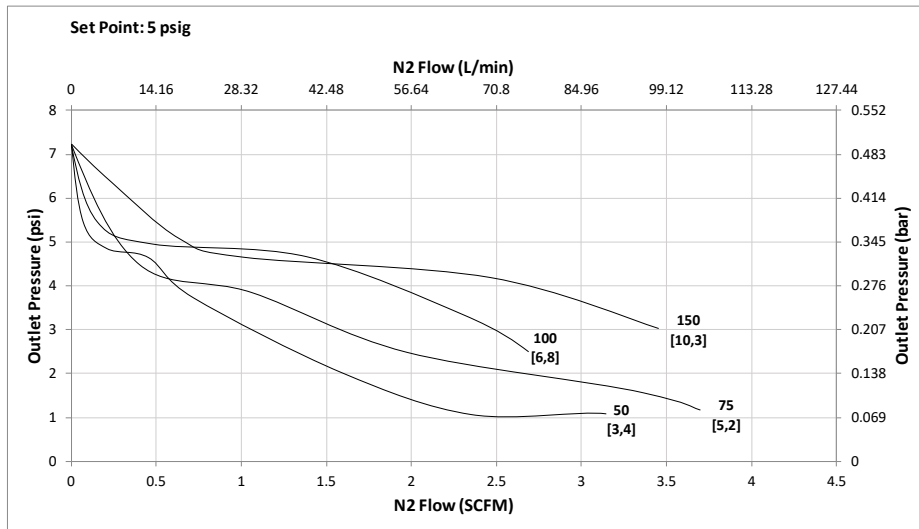
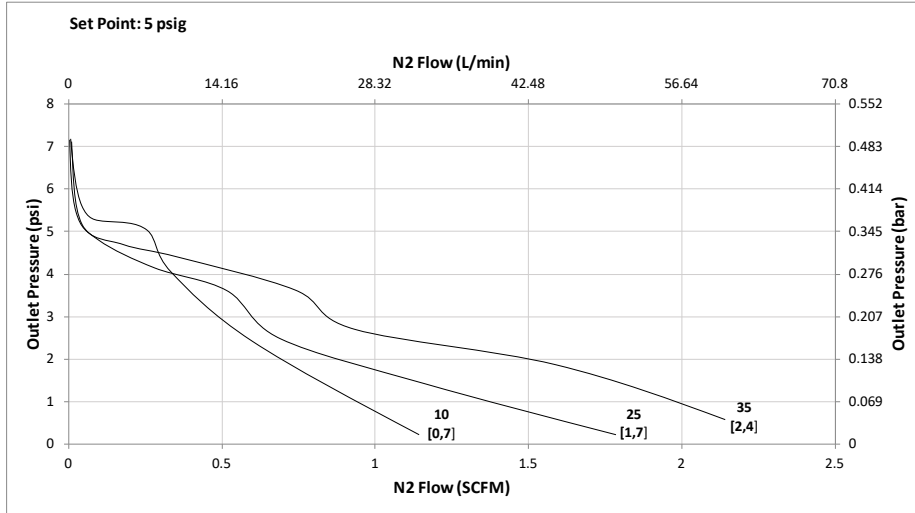

FLOW DATA FOR CV TRIM SELECTION

The graphs illustrate the change or "droop" in outlet pressures as the flow rate increases, and the lockup (setpoint rise) as flow decreases and approaches zero.

Flow Coefficient: 0.5

Range Spring: 5 - 70 psig (0,34 - 4,8 bar)

Maximum inlet pressure: 150 psig (10,3 bar)

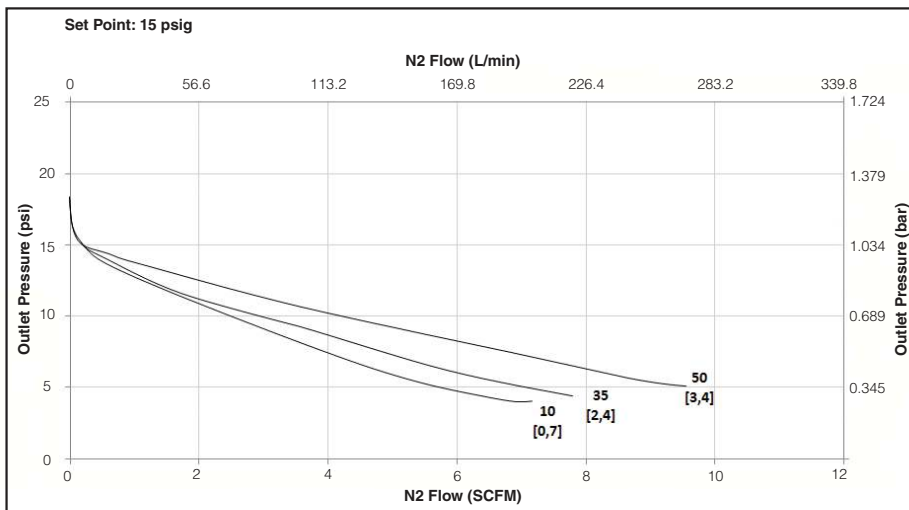
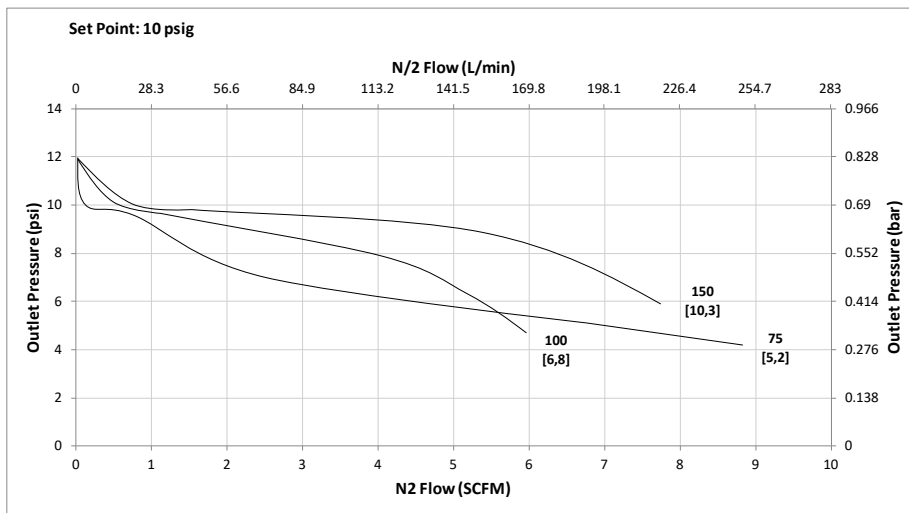
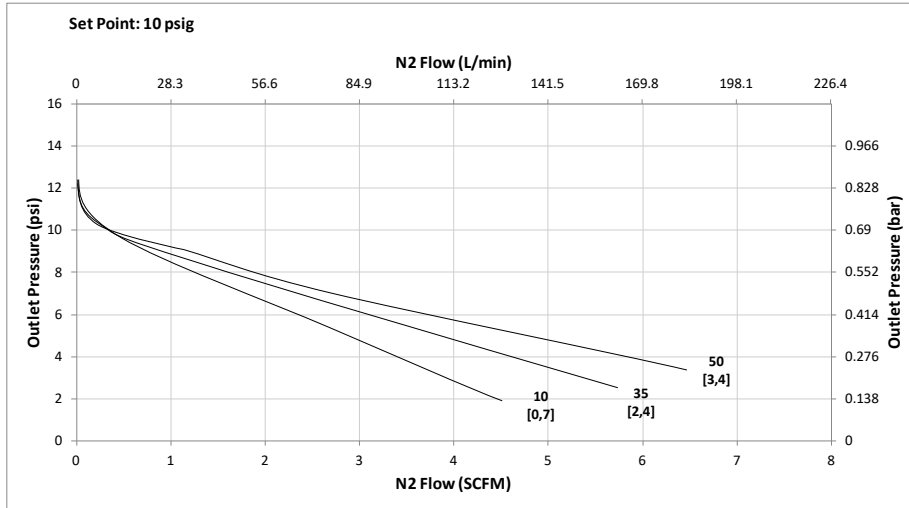

FLOW DATA FOR CV TRIM SELECTION

The graphs illustrate the change or "droop" in outlet pressures as the flow rate increases, and the lockup (setpoint rise) as flow decreases and approaches zero.

Flow Coefficient: 0.5

Range Spring: 5 - 70 psig (0,34 - 4,8 bar)

Maximum inlet pressure: 150 psig (10,3 bar)

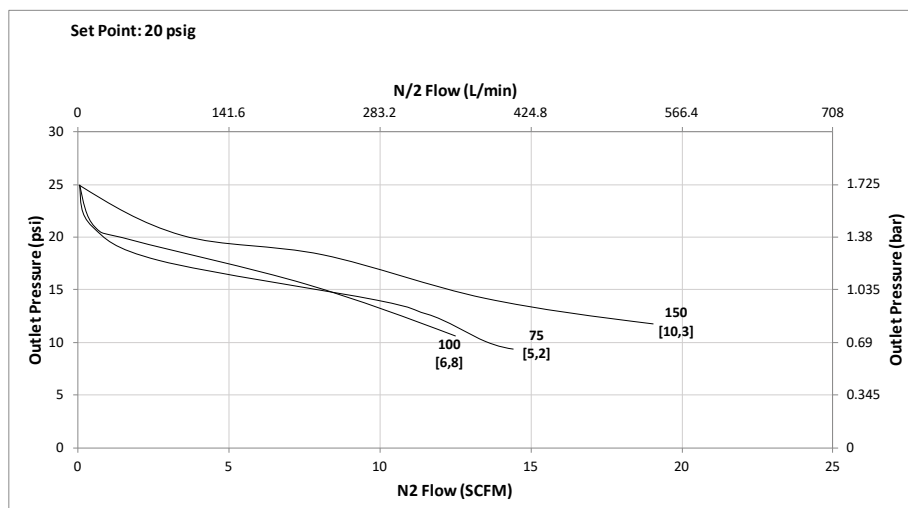
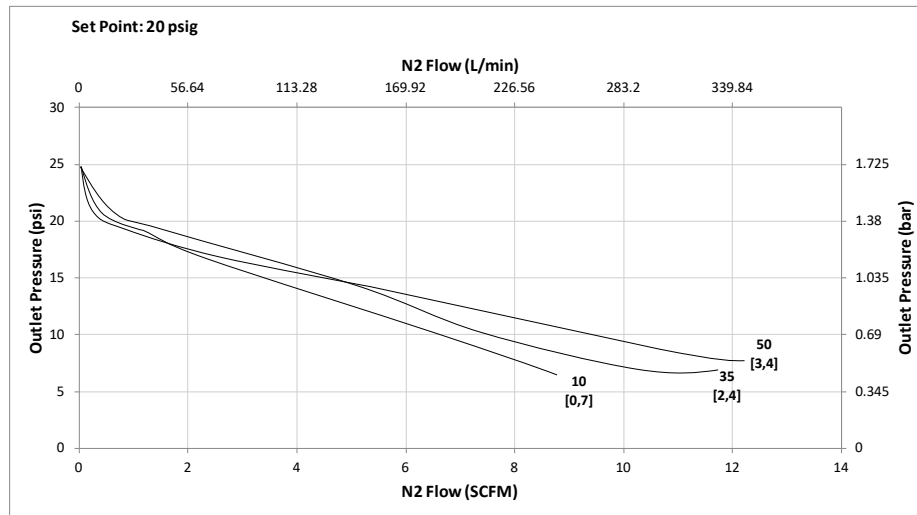
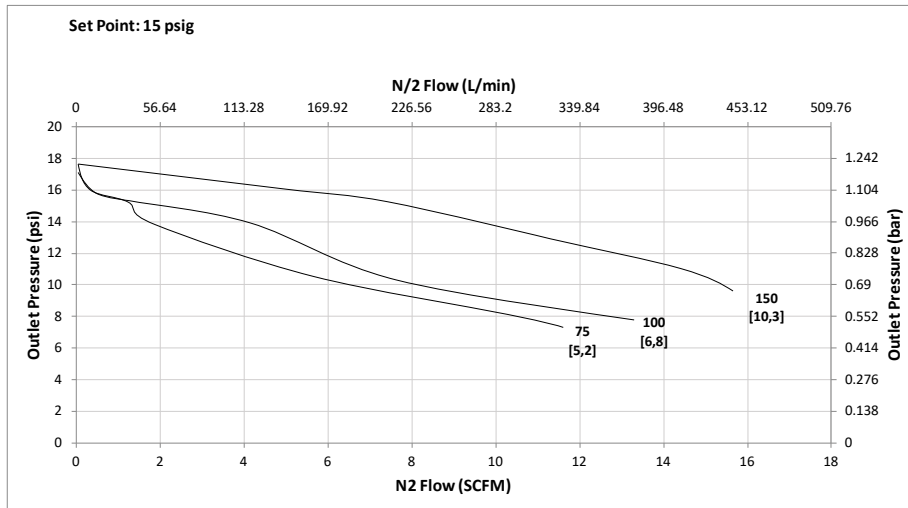

FLOW DATA FOR CV TRIM SELECTION

The graphs illustrate the change or "droop" in outlet pressures as the flow rate increases, and the lockup (setpoint rise) as flow decreases and approaches zero.

Flow Coefficient: 0.5

Range Spring: 5 - 70 psig (0,34 - 4,8 bar)

Maximum inlet pressure: 150 psig (10,3 bar)

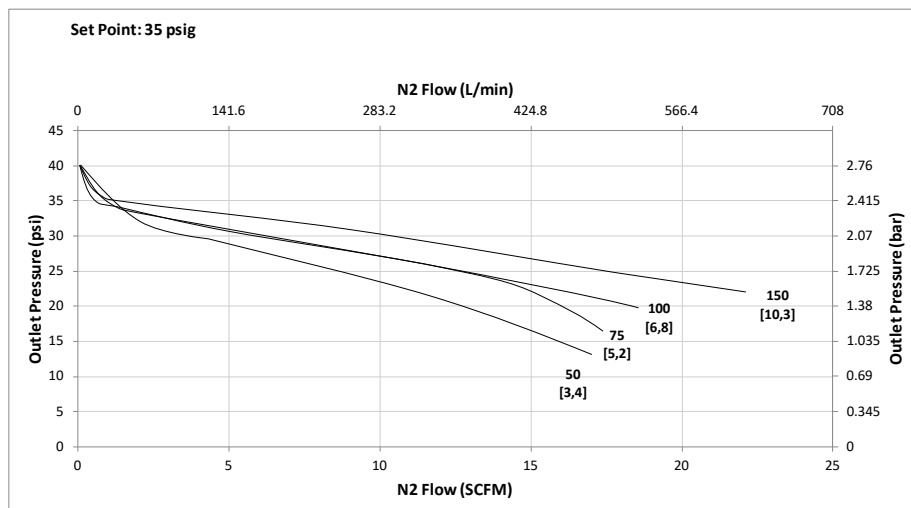
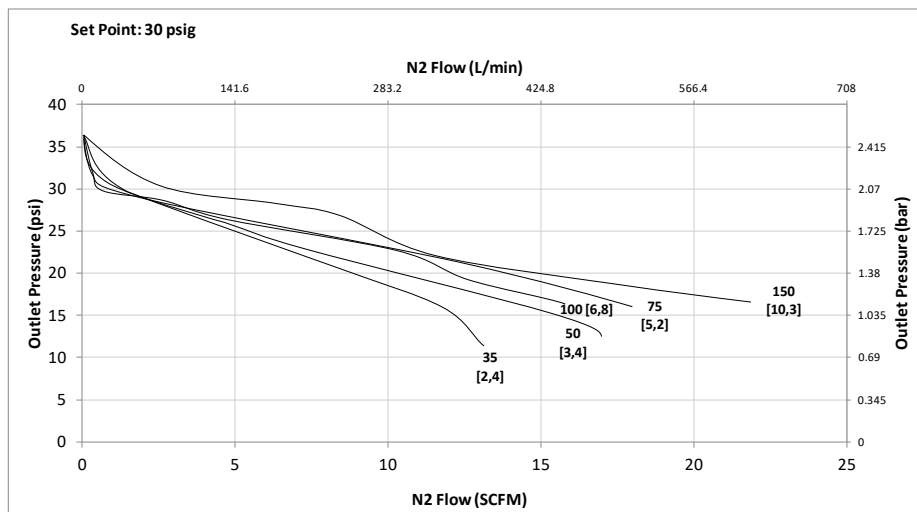
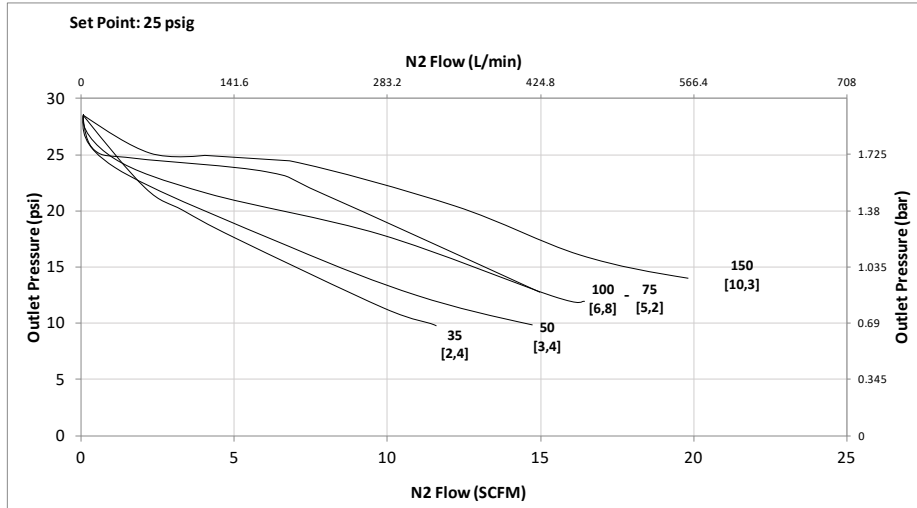

FLOW DATA FOR CV TRIM SELECTION

The graphs illustrate the change or "droop" in outlet pressures as the flow rate increases, and the lockup (setpoint rise) as flow decreases and approaches zero.

Flow Coefficient: 0.5

Range Spring: 5 - 70 psig (0,34 - 4,8 bar)

Maximum inlet pressure: 150 psig (10,3 bar)

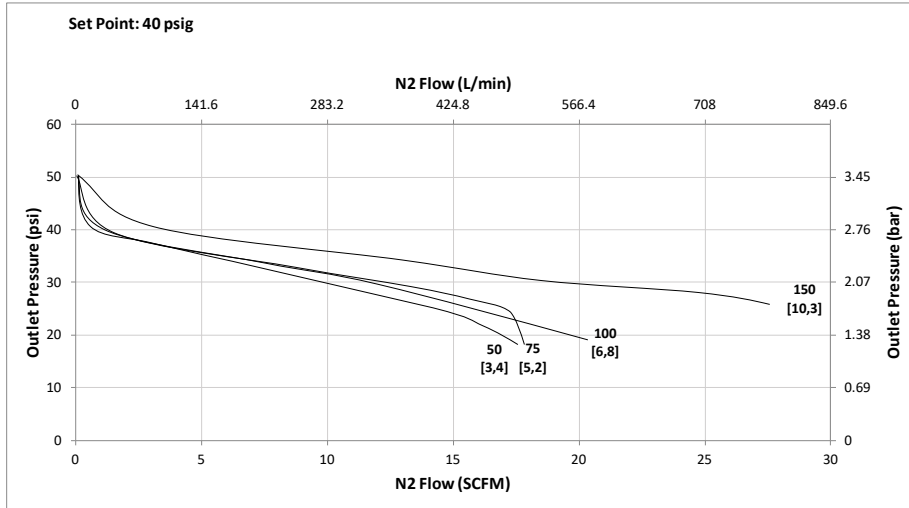

Flow Coefficient: 0.5

Range Spring: 15 - 90 psig (1,03 - 6,2 bar)

Maximum inlet pressure: 150 psig (10,3 bar)

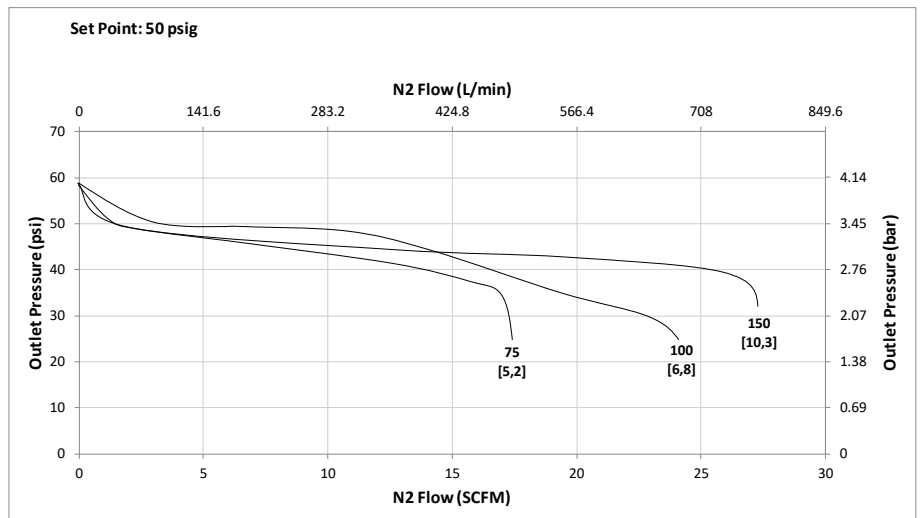
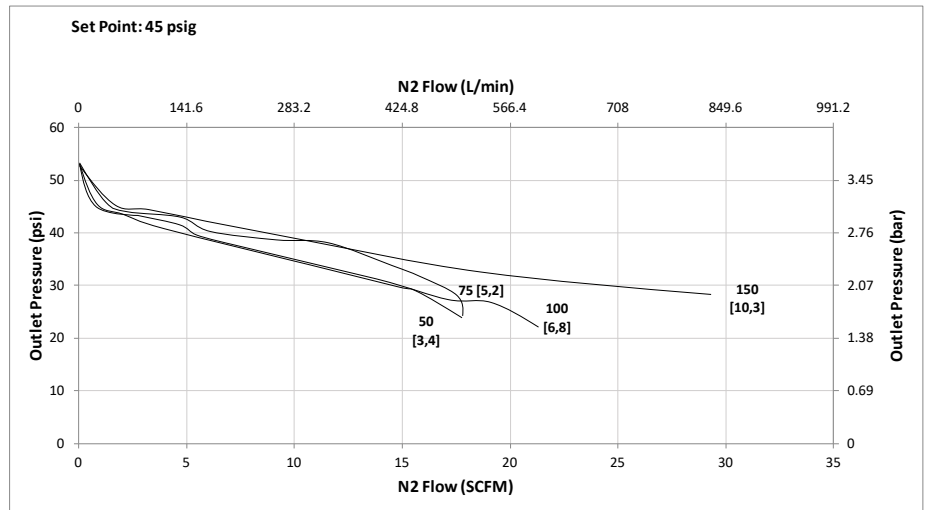

FLOW DATA FOR CV TRIM SELECTION

The graphs illustrate the change or "droop" in outlet pressures as the flow rate increases, and the lockup (setpoint rise) as flow decreases and approaches zero.

Flow Coefficient: 0.5

Range Spring: 15 - 90 psig (1,03 - 6,2 bar)

Maximum inlet pressure: 150 psig (10,3 bar)

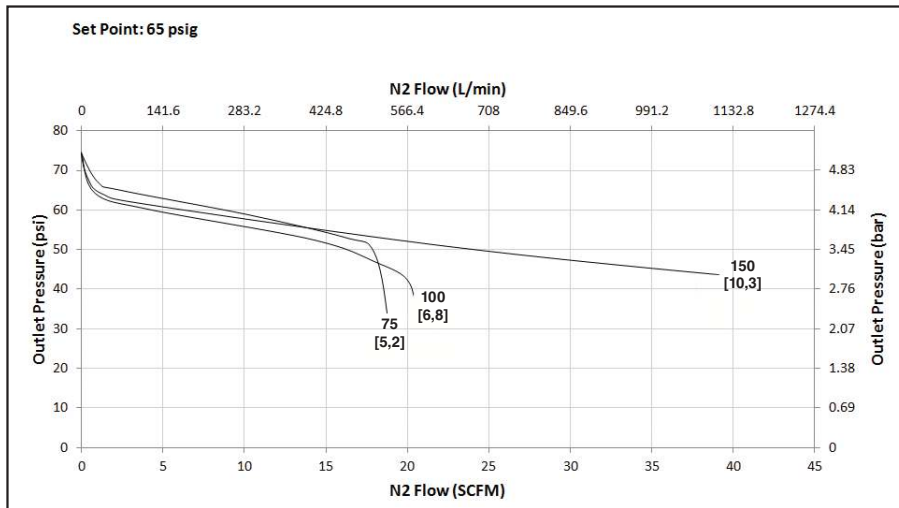
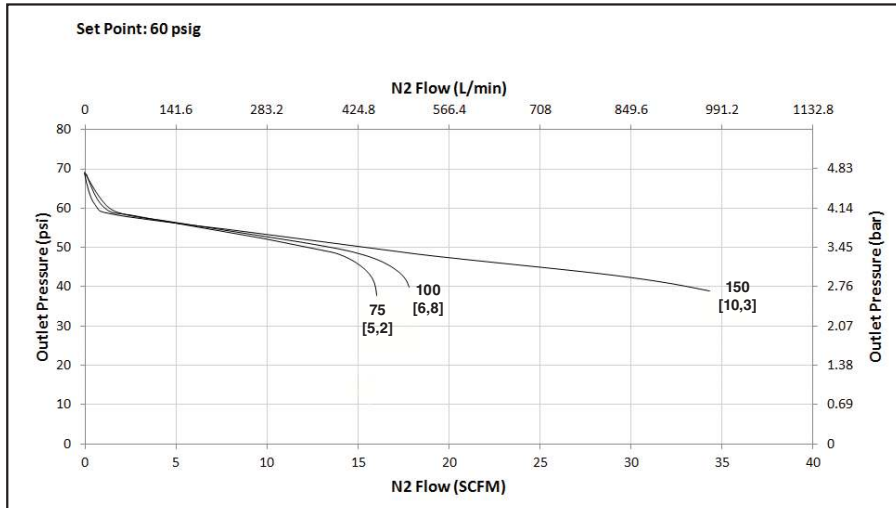
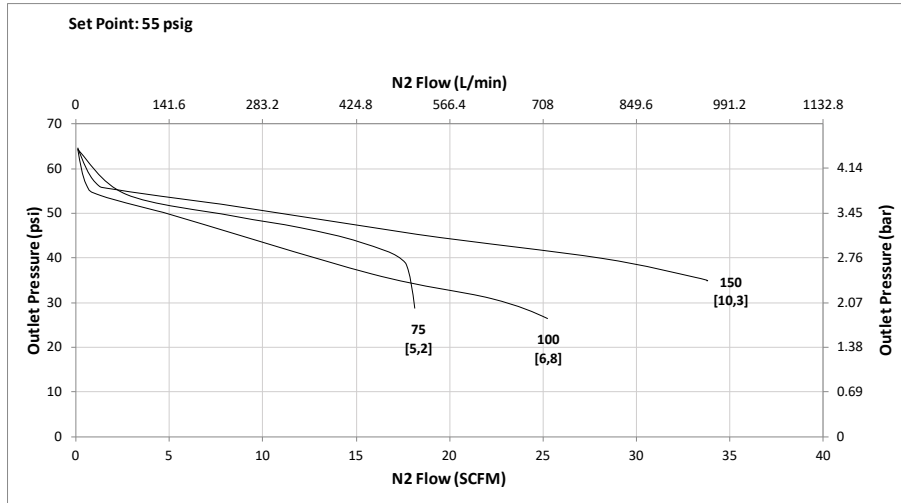

FLOW DATA FOR CV TRIM SELECTION

The graphs illustrate the change or "droop" in outlet pressures as the flow rate increases, and the lockup (setpoint rise) as flow decreases and approaches zero.

Flow Coefficient: 0.5

Range Spring: 15 - 90 psig (1,03 - 6,2 bar)

Maximum inlet pressure: 150 psig (10,3 bar)

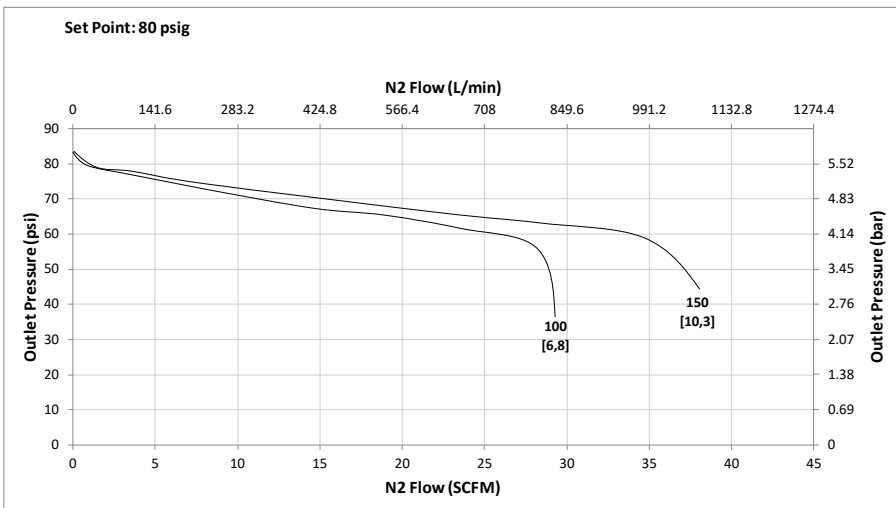
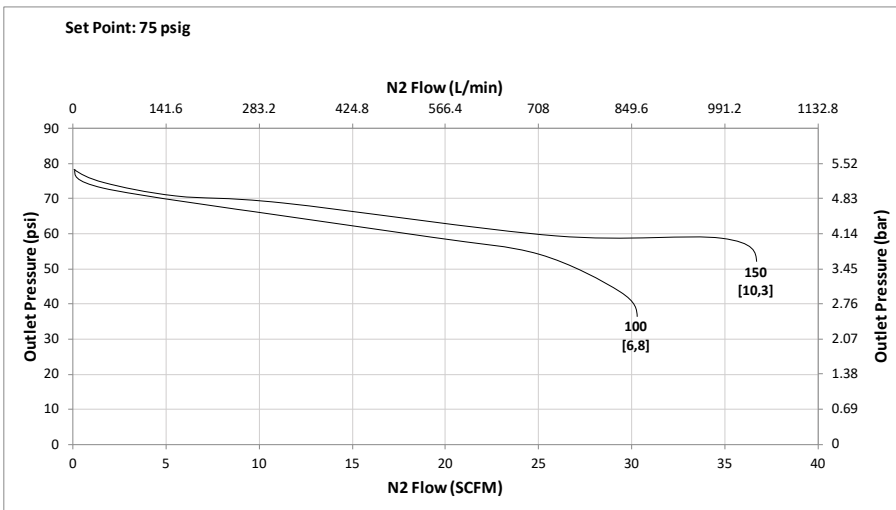
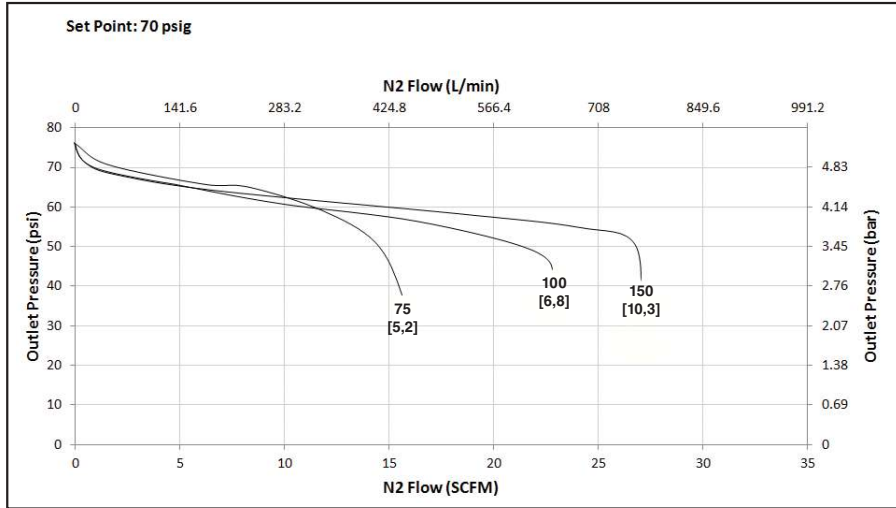

FLOW DATA FOR CV TRIM SELECTION

The graphs illustrate the change or "droop" in outlet pressures as the flow rate increases, and the lockup (setpoint rise) as flow decreases and approaches zero.

Flow Coefficient: 0.5

Range Spring: 15 - 90 psig (1,03 - 6,2 bar)

Maximum inlet pressure: 150 psig (10,3 bar)

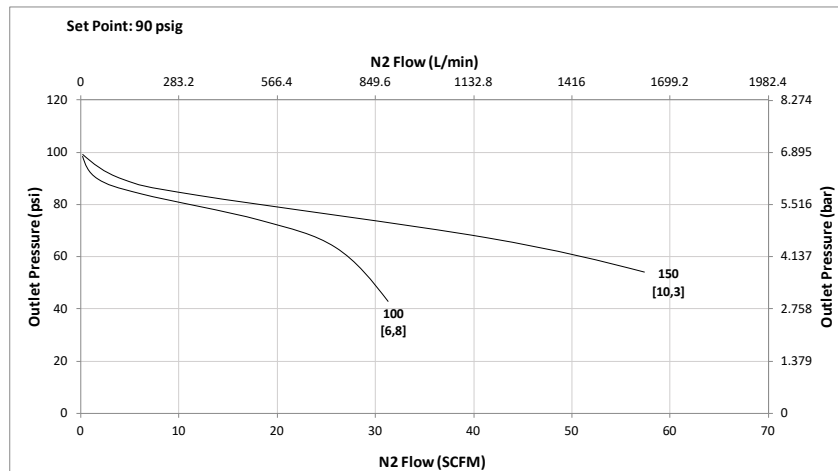
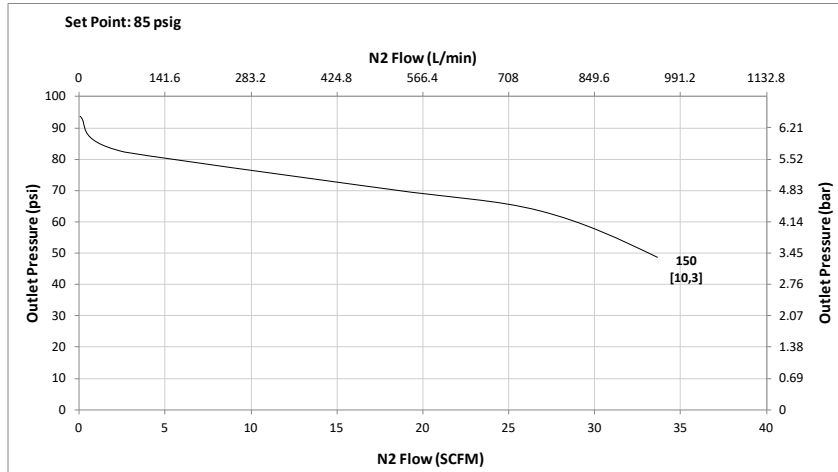

Flow Coefficient: 0.5

Range Spring: 50 -125 psig (3,4 - 8,6 bar)

Maximum inlet pressure: 150 psig (10,3 bar)

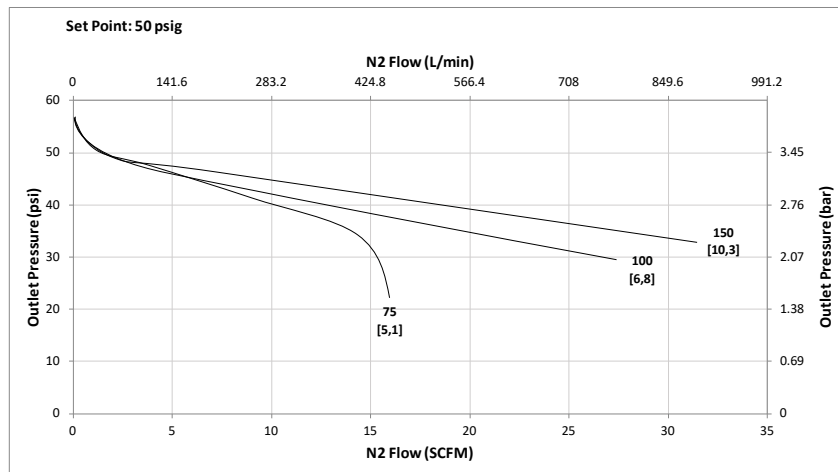

FLOW DATA FOR CV TRIM SELECTION

The graphs illustrate the change or "droop" in outlet pressures as the flow rate increases, and the lockup (setpoint rise) as flow decreases and approaches zero.

Flow Coefficient: 0.5

Range Spring: 50 -125 psig (3,4 - 8,6 bar)

Maximum inlet pressure: 150 psig (10,3 bar)

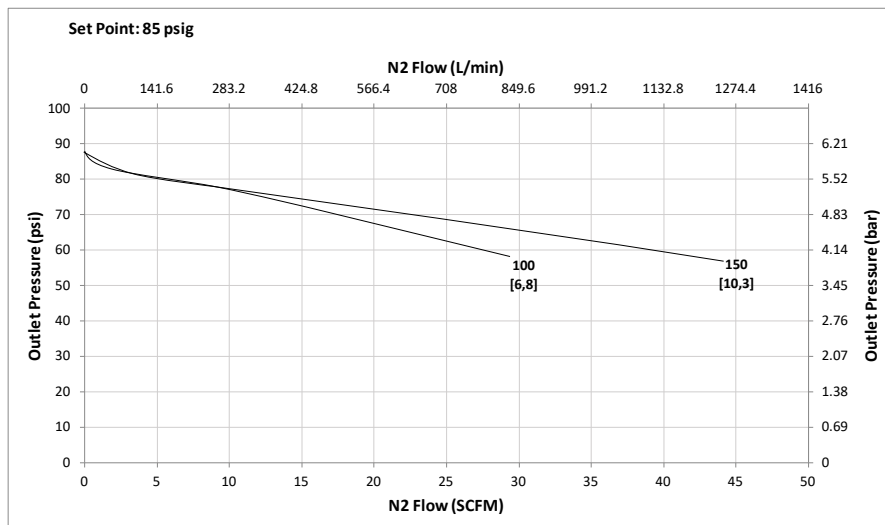
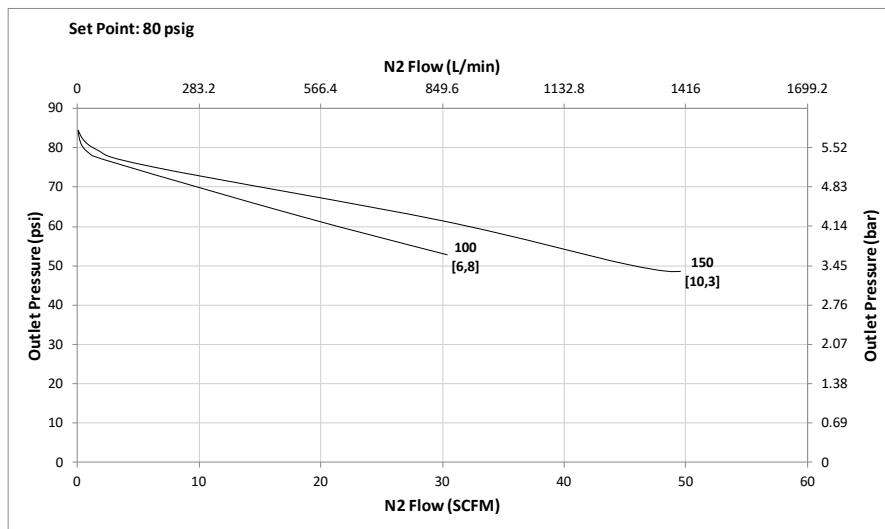
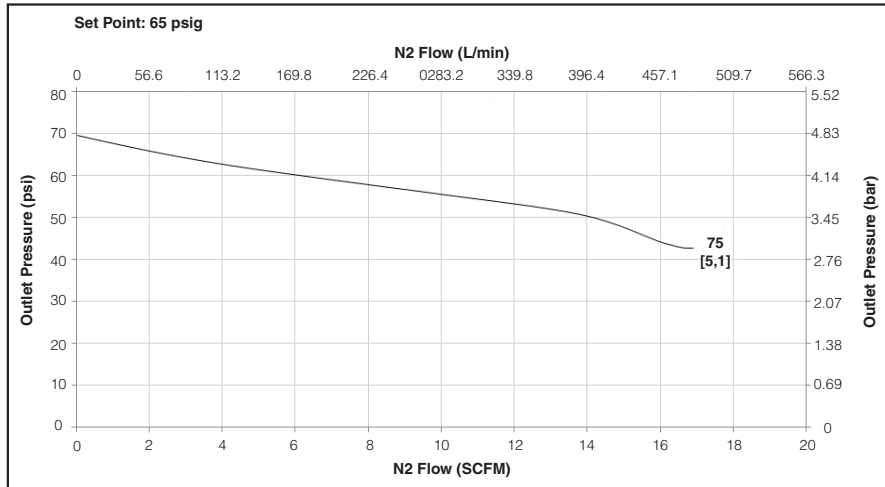

FLOW DATA FOR CV TRIM SELECTION

The graphs illustrate the change or "droop" in outlet pressures as the flow rate increases, and the lockup (setpoint rise) as flow decreases and approaches zero.

Flow Coefficient: 0.5

Range Spring: 50 -125 psig (3,4 - 8,6 bar)

Maximum inlet pressure: 150 psig (10,3 bar)

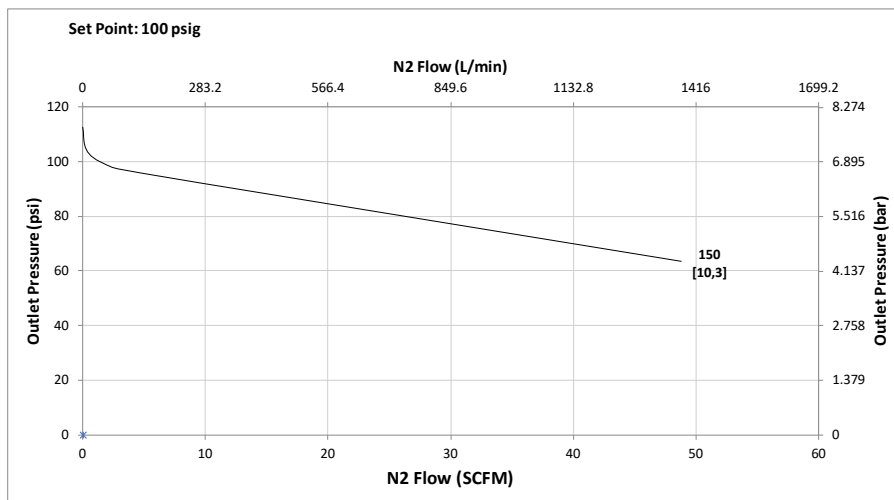
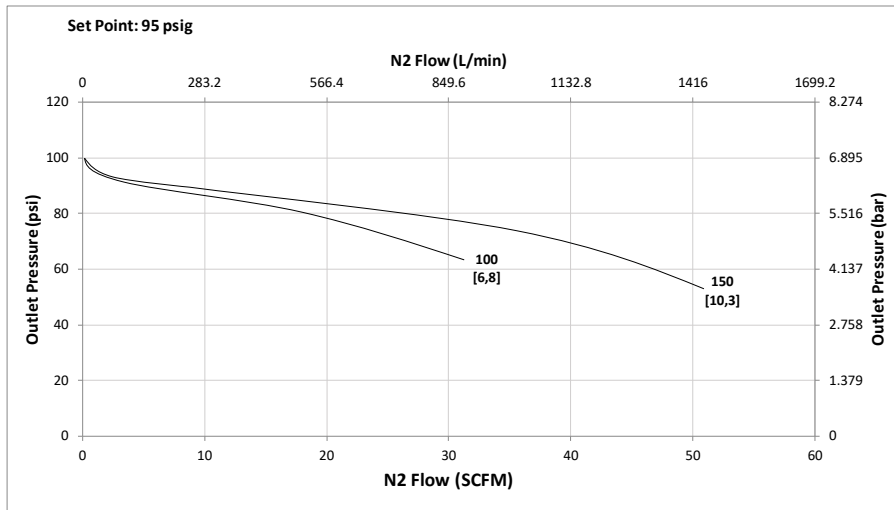
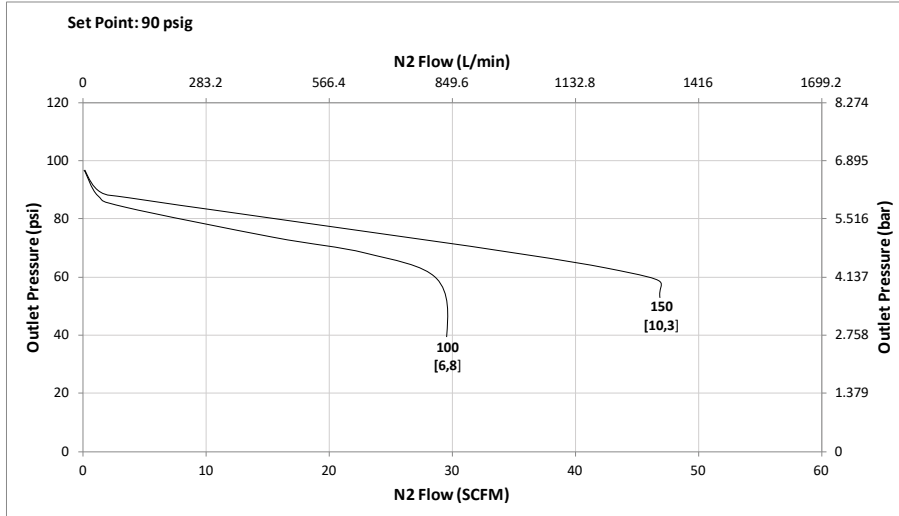

FLOW DATA FOR CV TRIM SELECTION

The graphs illustrate the change or "droop" in outlet pressures as the flow rate increases, and the lockup (setpoint rise) as flow decreases and approaches zero.

Flow Coefficient: 0.5

Range Spring: 50 -125 psig (3,4 - 8,6 bar)

Maximum inlet pressure: 150 psig (10,3 bar)

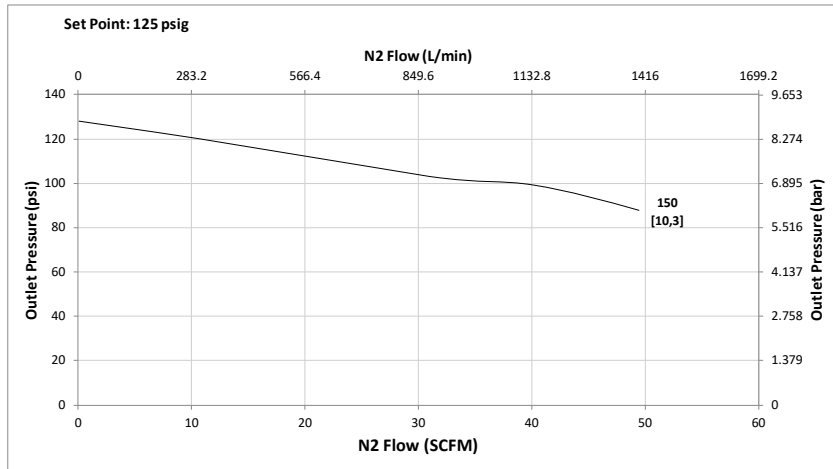
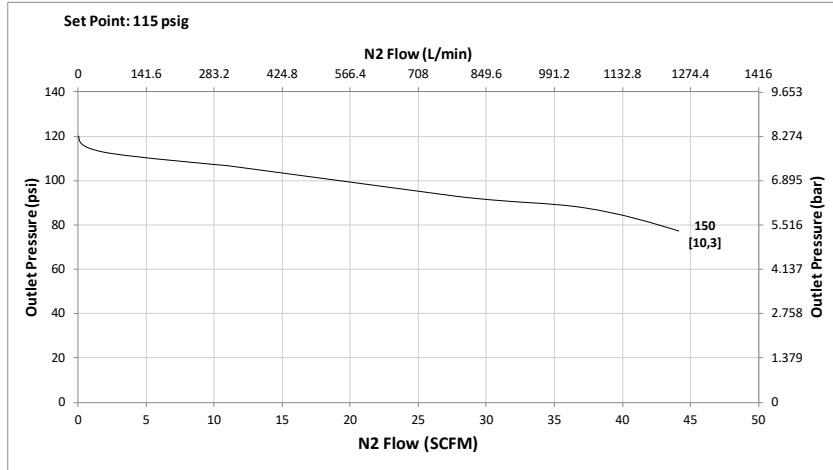

FLOW DATA FOR CV TRIM SELECTION

Flow Coefficient: 0.8

Range Spring: 5 - 70 psig (0,34 - 4,8 bar)

Maximum inlet pressure: 150 psig (10,3 bar)

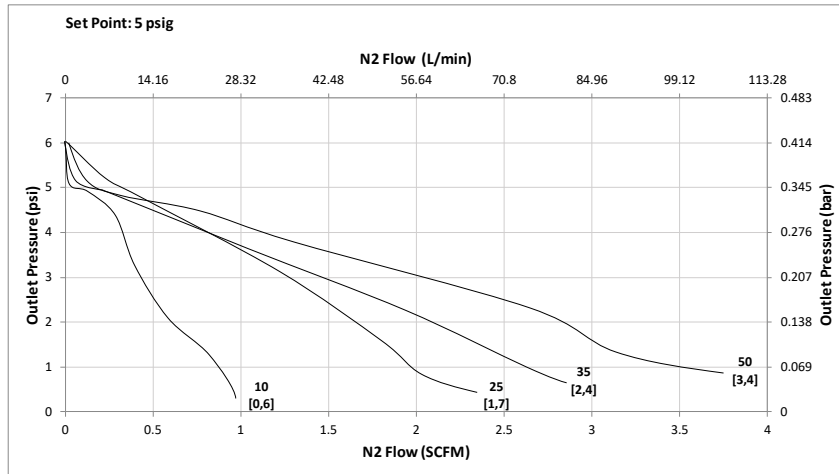

FLOW DATA FOR CV TRIM SELECTION

The graphs illustrate the change or "droop" in outlet pressures as the flow rate increases, and the lockup (setpoint rise) as flow decreases and approaches zero.

Flow Coefficient: 0.8

Range Range Spring: 5 - 70 psig (0,34 - 4,8 bar)

Maximum inlet pressure: 150 psig (10,3 bar)

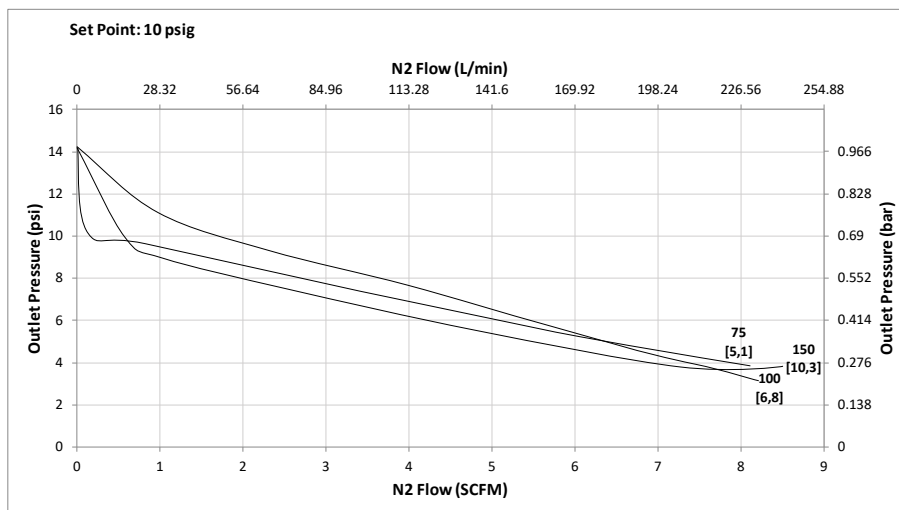
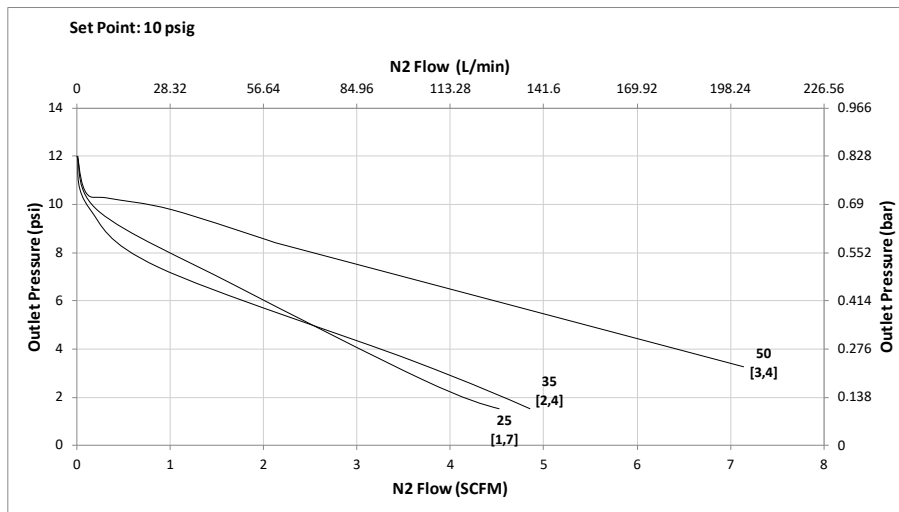
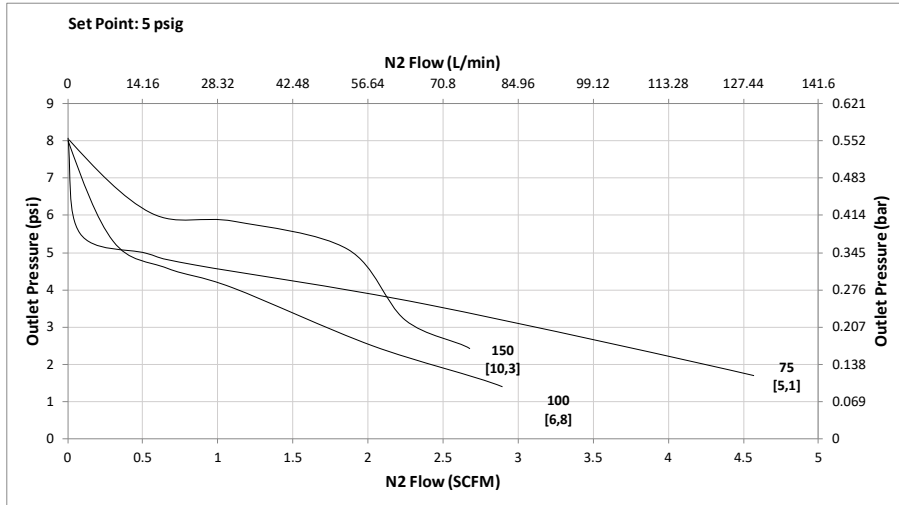

FLOW DATA FOR CV TRIM SELECTION

The graphs illustrate the change or "droop" in outlet pressures as the flow rate increases, and the lockup (setpoint rise) as flow decreases and approaches zero.

Flow Coefficient: 0.8

Range Spring: 5 - 70 psig (0,34 - 4,8 bar)

Maximum inlet pressure: 150 psig (10,3 bar)

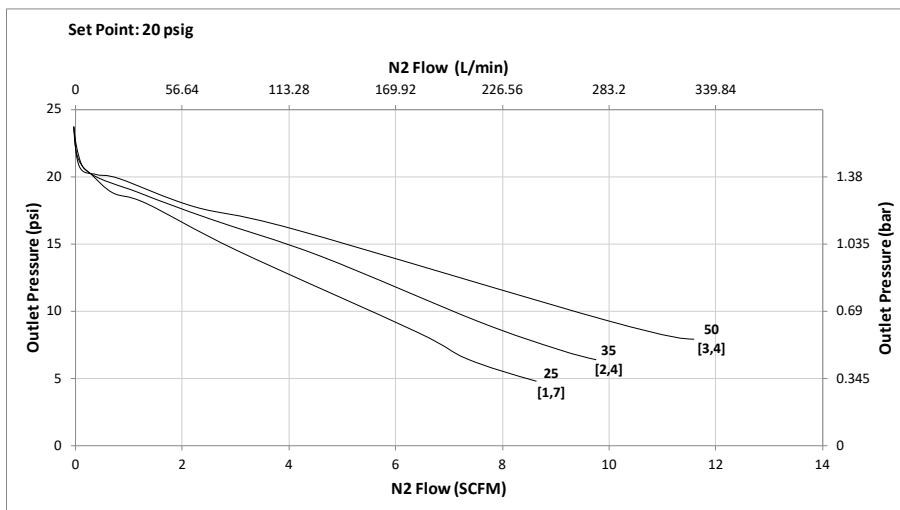
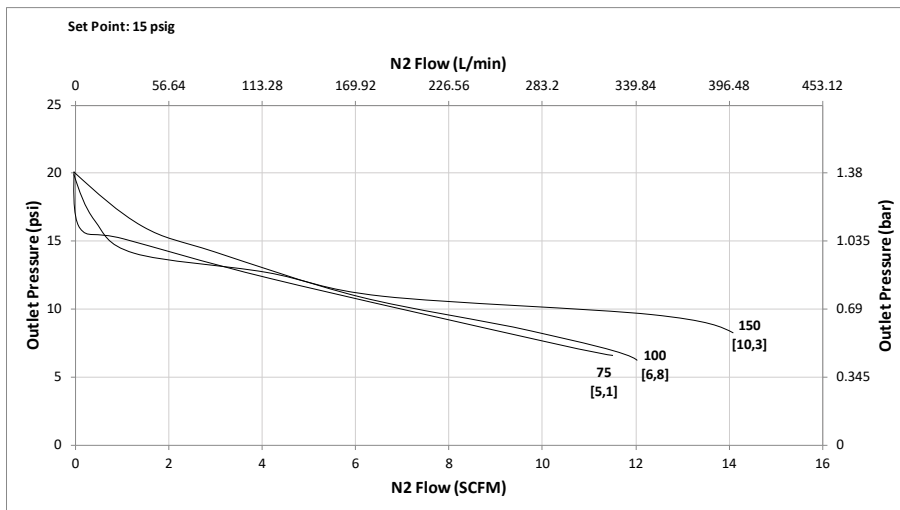
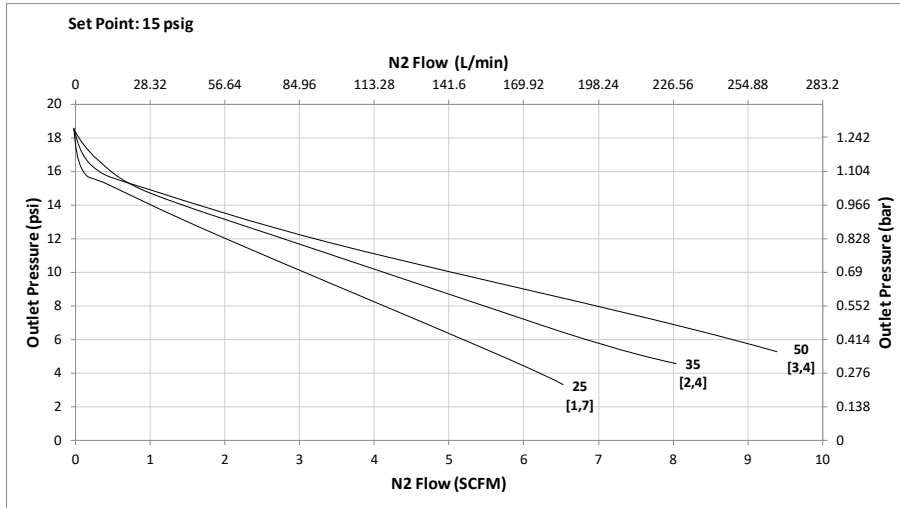

FLOW DATA FOR CV TRIM SELECTION

The graphs illustrate the change or "droop" in outlet pressures as the flow rate increases, and the lockup (setpoint rise) as flow decreases and approaches zero.

Flow Coefficient: 0.8

Range Spring: 5 - 70 psig (0,34 - 4,8 bar)

Maximum inlet pressure: 150 psig (10,3 bar)

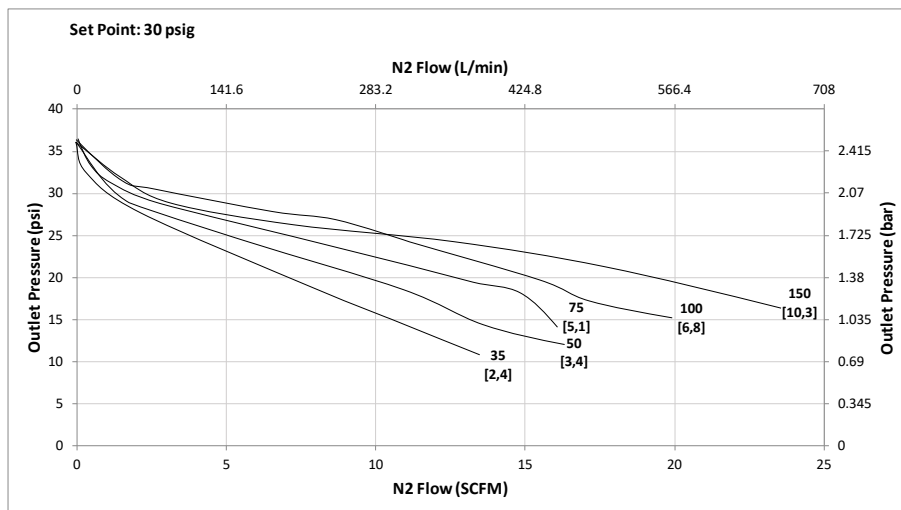
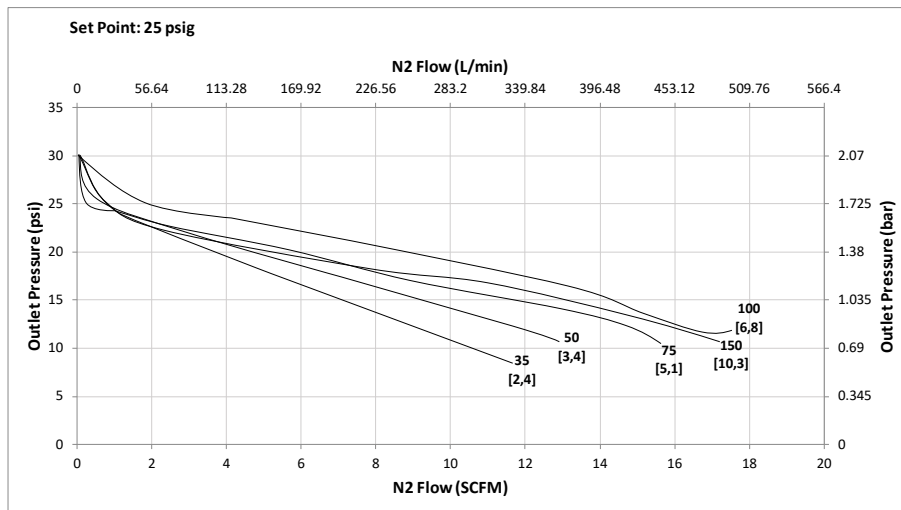
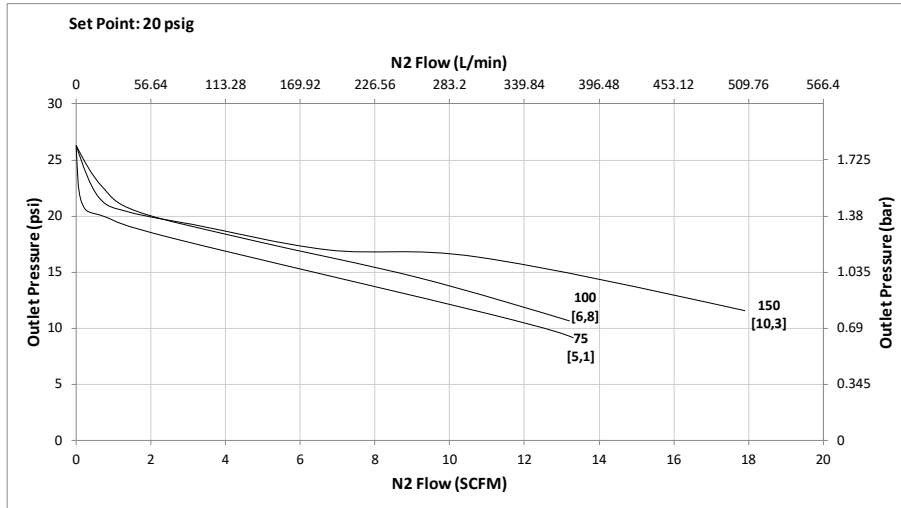

FLOW DATA FOR CV TRIM SELECTION

The graphs illustrate the change or "droop" in outlet pressures as the flow rate increases, and the lockup (setpoint rise) as flow decreases and approaches zero.

Flow Coefficient: 0.8

Range Spring: 5 - 70 psig (0,34 - 4,8 bar)

Maximum inlet pressure: 150 psig (10,3 bar)

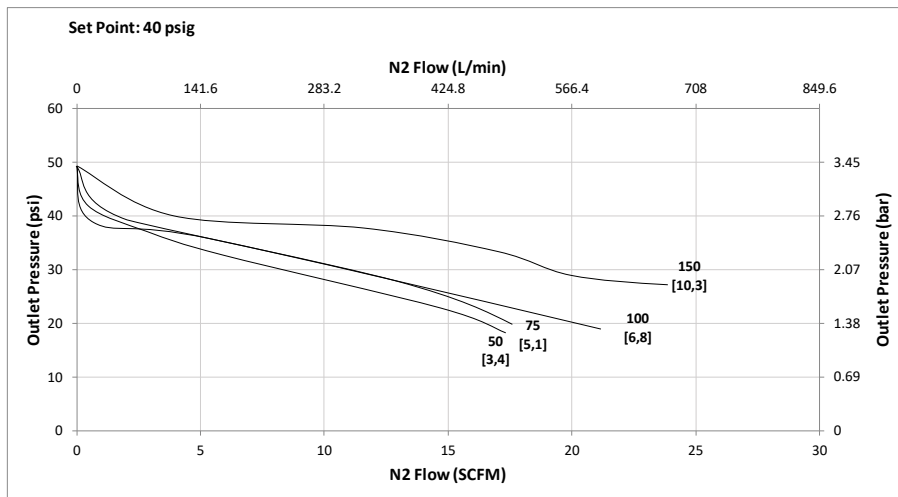
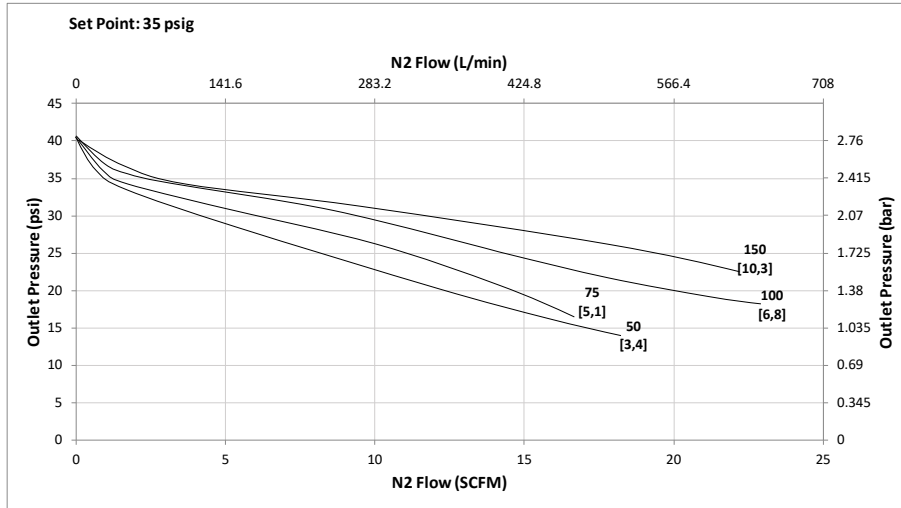

Flow Coefficient: 0.8

Range Spring: 15 - 90 psig (1,03 - 6,2 bar)

Maximum inlet pressure: 150 psig (10,3 bar)

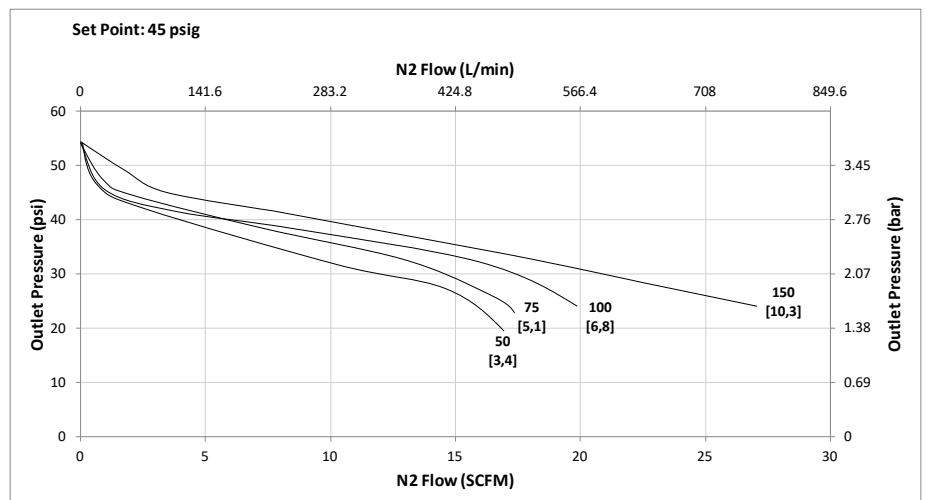

FLOW DATA FOR CV TRIM SELECTION

The graphs illustrate the change or "droop" in outlet pressures as the flow rate increases, and the lockup (setpoint rise) as flow decreases and approaches zero.

Flow Coefficient: 0.8

Range Spring: 15 - 90 psig (1,03 - 6,2 bar)

Maximum inlet pressure: 150 psig (10,3 bar)

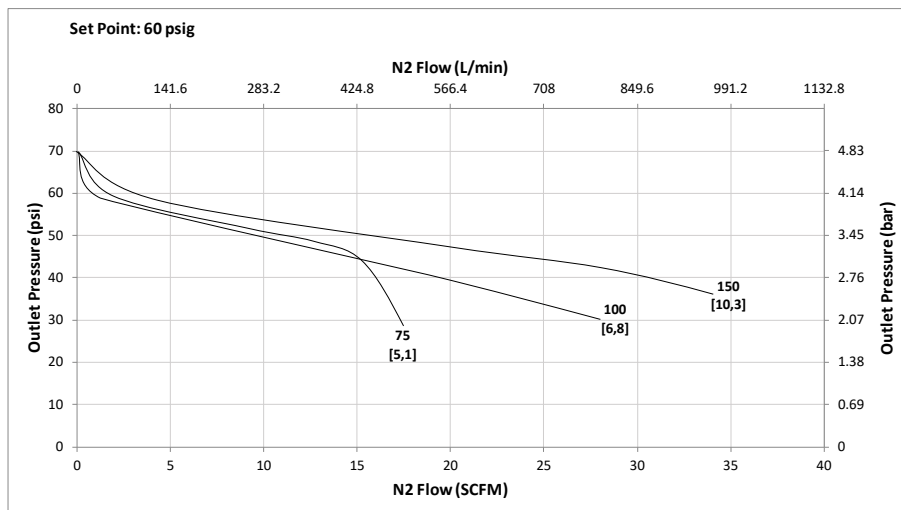
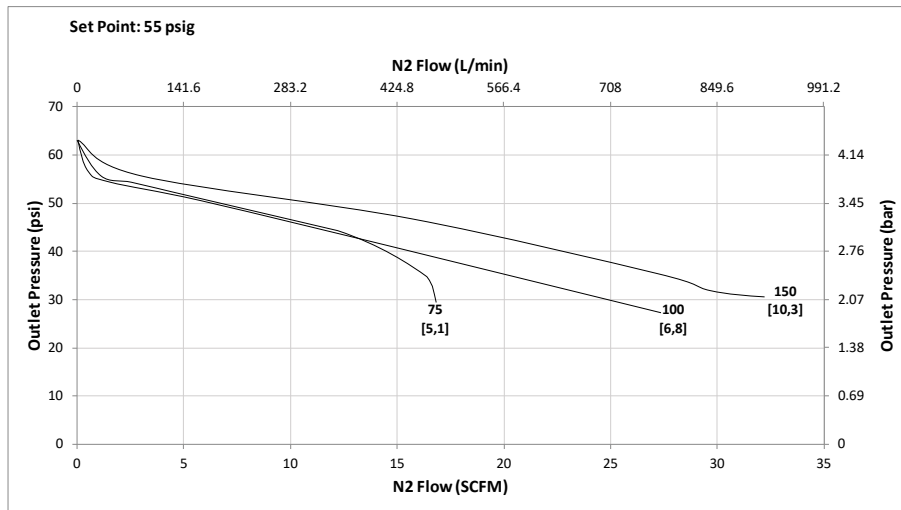
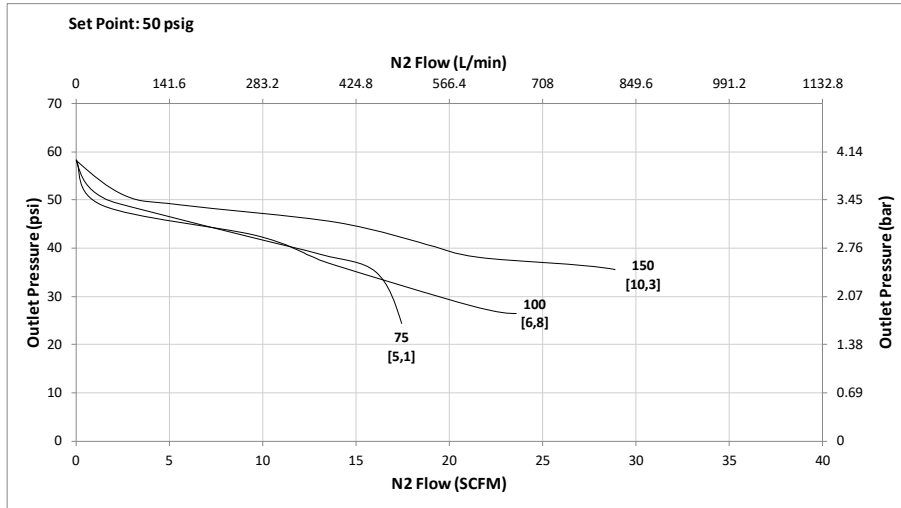

FLOW DATA FOR CV TRIM SELECTION

The graphs illustrate the change or "droop" in outlet pressures as the flow rate increases, and the lockup (setpoint rise) as flow decreases and approaches zero.

Flow Coefficient: 0.8

Range Spring: 15 - 90 psig (1,03 - 6,2 bar)

Maximum inlet pressure: 150 psig (10,3 bar)

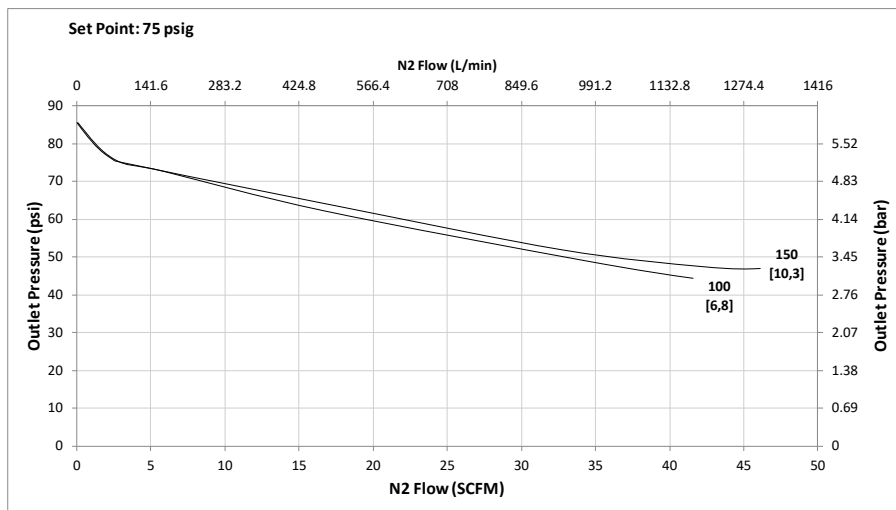
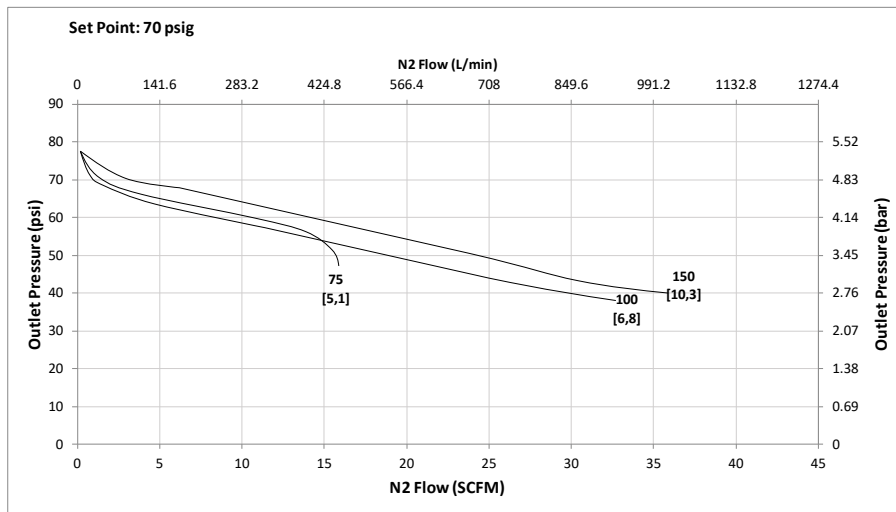
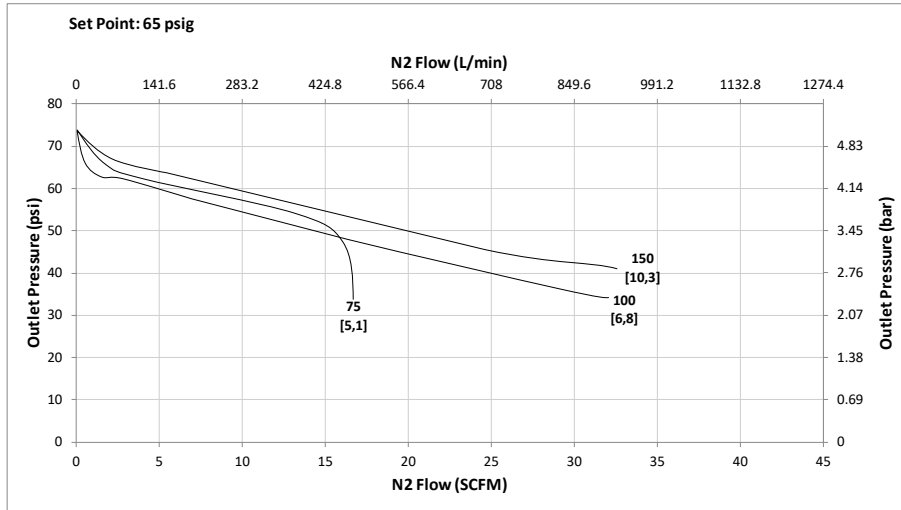

FLOW DATA FOR CV TRIM SELECTION

The graphs illustrate the change or "droop" in outlet pressures as the flow rate increases, and the lockup (setpoint rise) as flow decreases and approaches zero.

Flow Coefficient: 0.8

Range Spring: 15 - 90 psig (1,03 - 6,2 bar)

Maximum inlet pressure: 150 psig (10,3 bar)

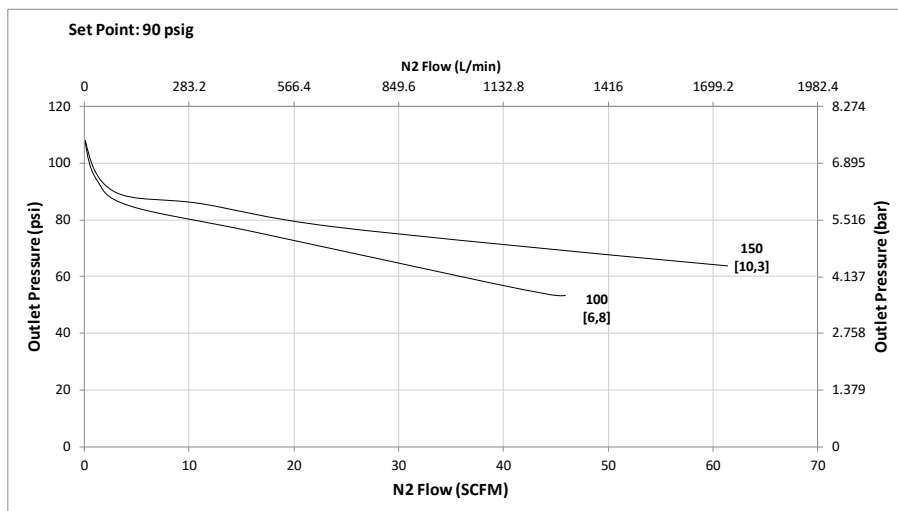
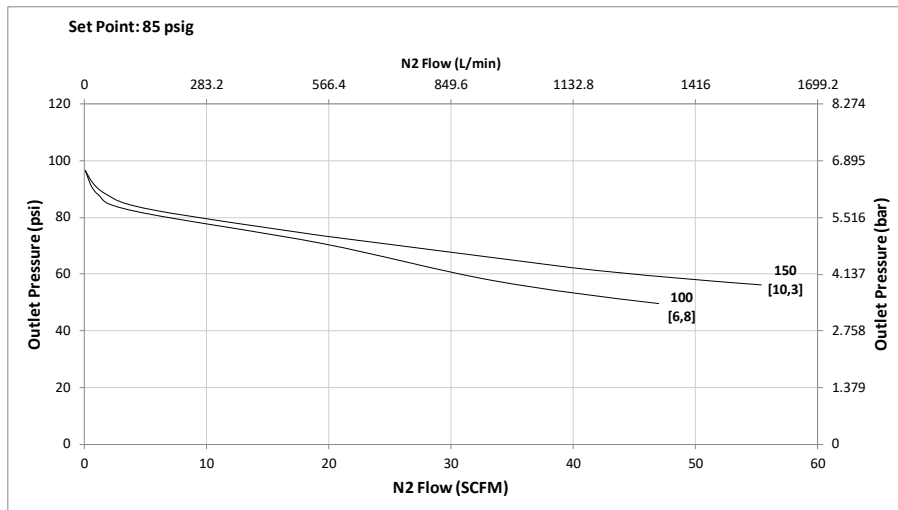
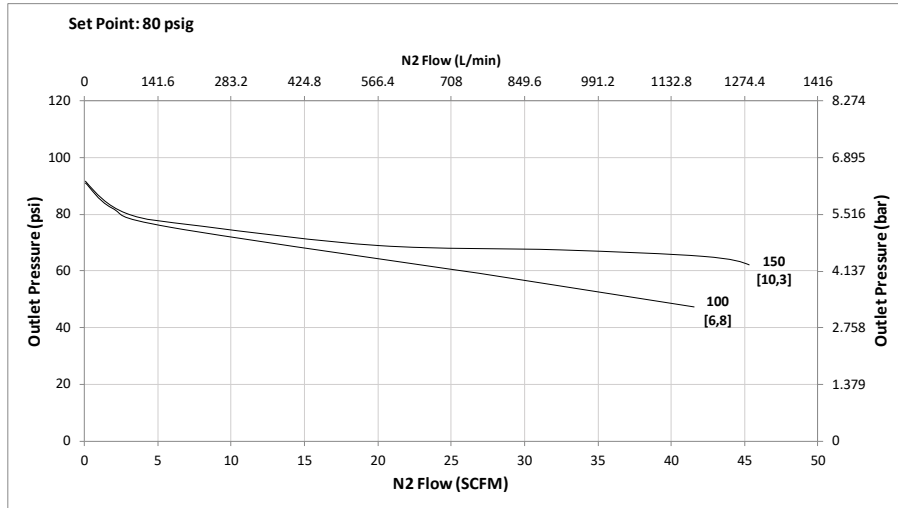

FLOW DATA FOR CV TRIM SELECTION

The graphs illustrate the change or "droop" in outlet pressures as the flow rate increases, and the lockup (setpoint rise) as flow decreases and approaches zero.

Flow Coefficient: 0.8

Range Spring: **50 -125 psig** (3,4 - 8,6 bar)

Maximum inlet pressure: 150 psig (10,3 bar)

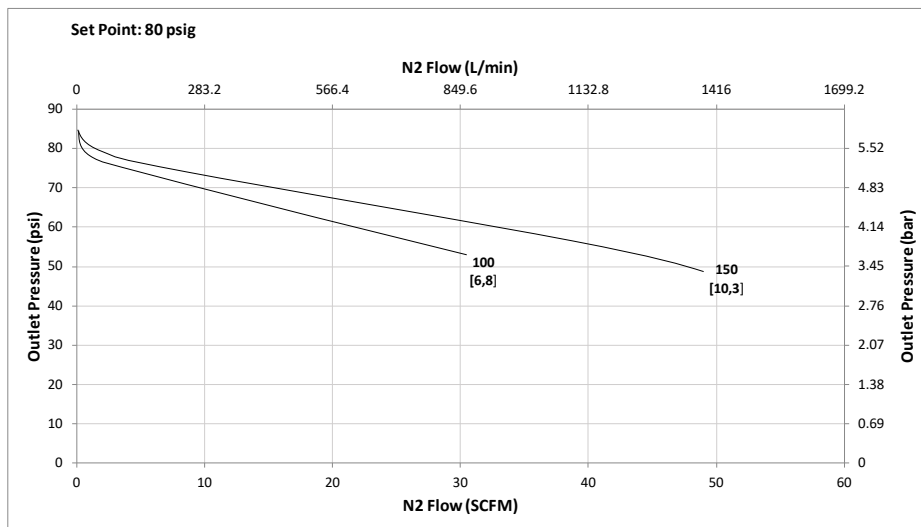
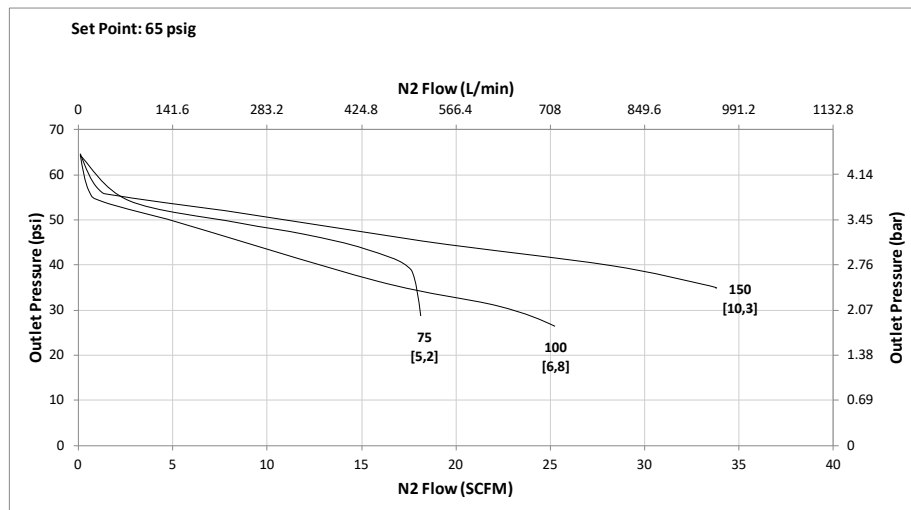
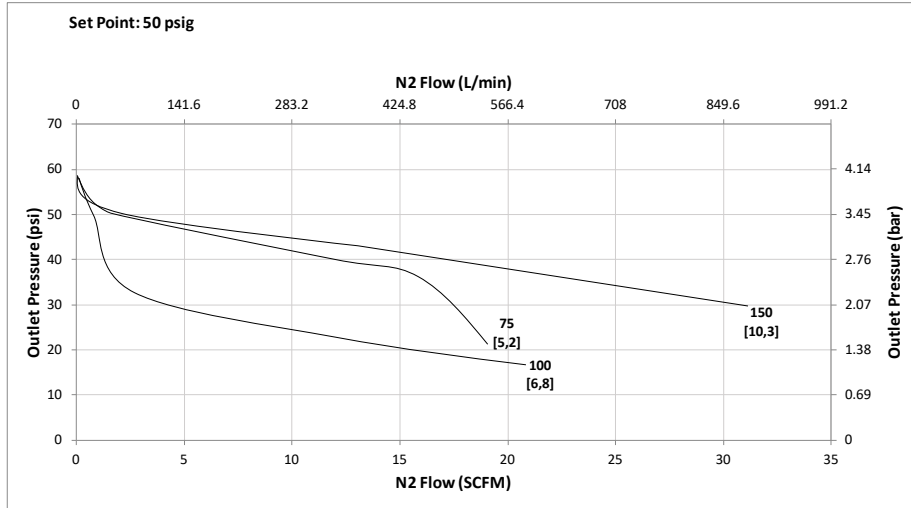

FLOW DATA FOR CV TRIM SELECTION

The graphs illustrate the change or "droop" in outlet pressures as the flow rate increases, and the lockup (setpoint rise) as flow decreases and approaches zero.

Flow Coefficient: 0.8

Range Spring: 50 -125 psig (3,4 - 8,6 bar)

Maximum inlet pressure: 150 psig (10,3 bar)

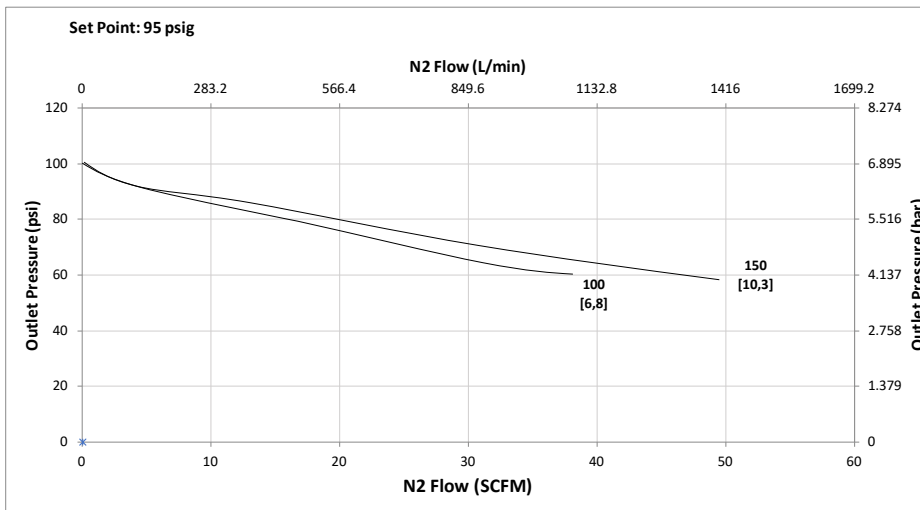
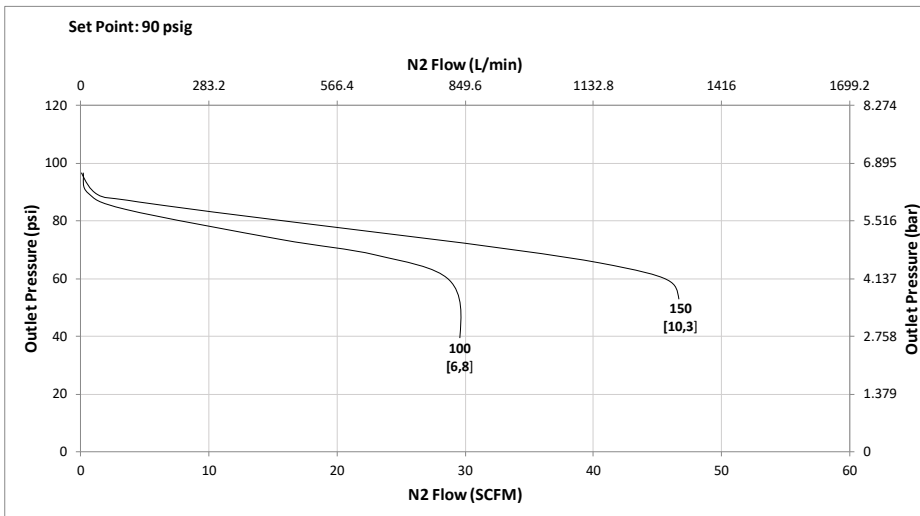
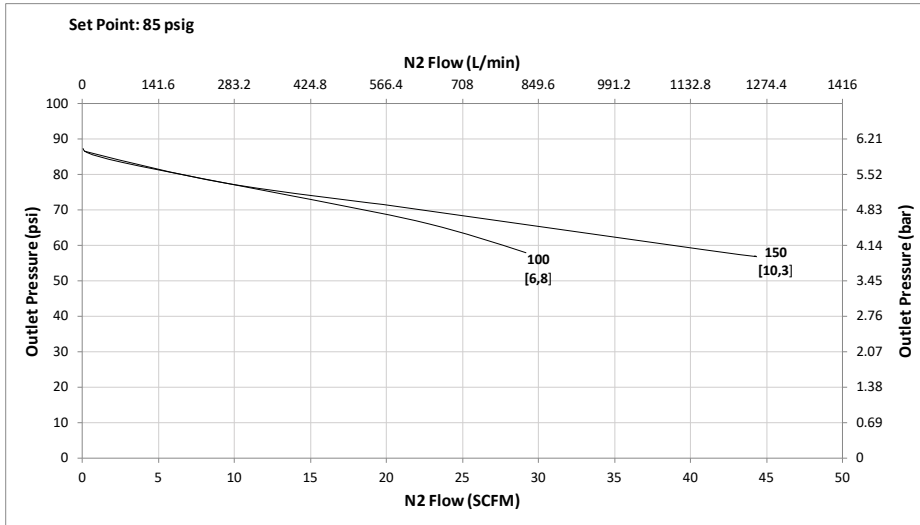

FLOW DATA FOR CV TRIM SELECTION

The graphs illustrate the change or "droop" in outlet pressures as the flow rate increases, and the lockup (setpoint rise) as flow decreases and approaches zero.

Flow Coefficient: 0.8

Range Spring: 50 -125 psig (3,4 - 8,6 bar)

Maximum inlet pressure: 150 psig (10,3 bar)

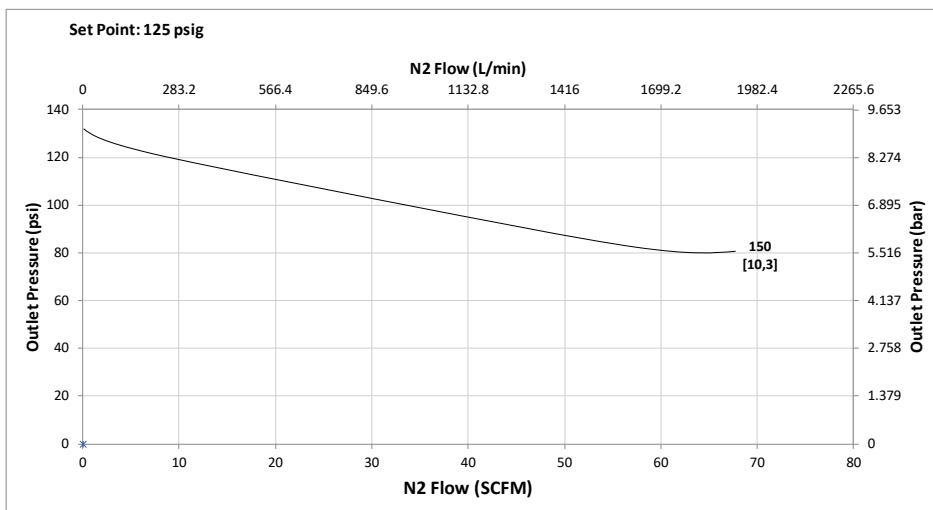
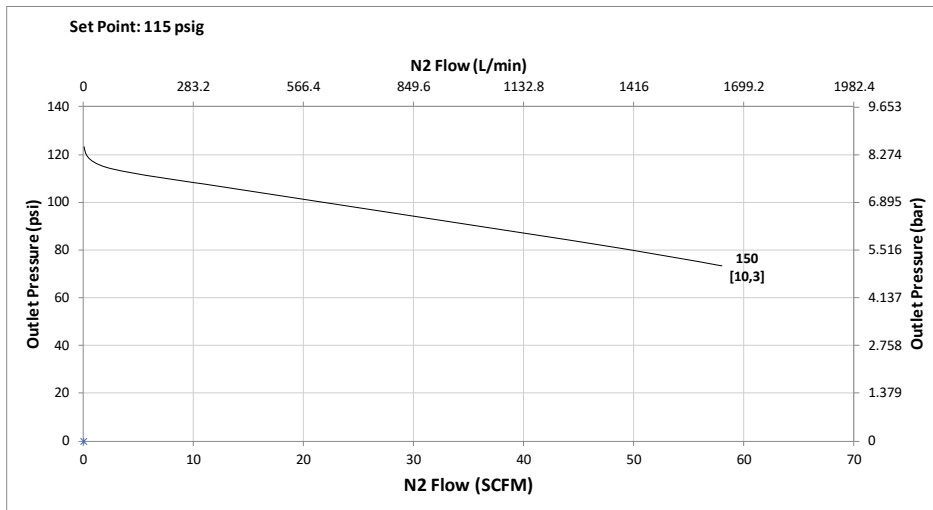
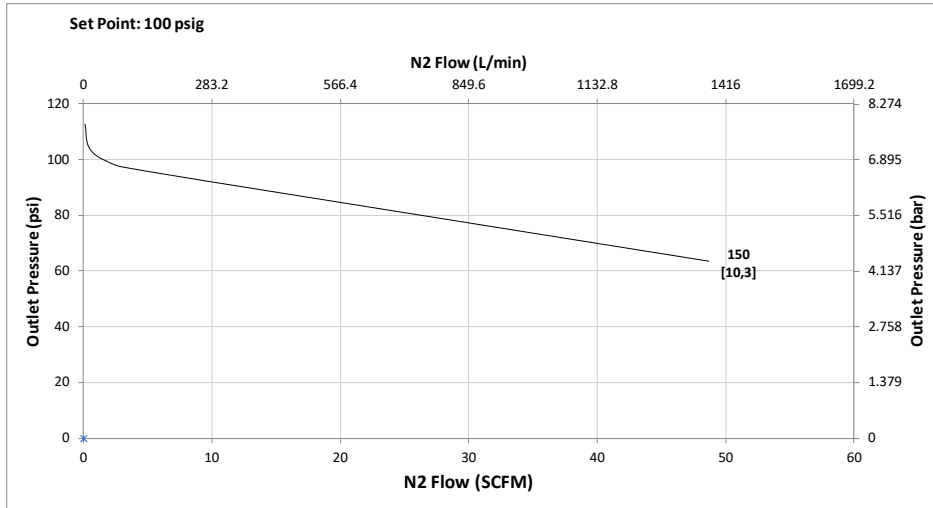

ORDERING SCHEMATIC

Model	Size	Material	1 & 2	3 & 4	5 & 6	7 & 8	9 & 10	11 & 12	13 & 14	15	16	17
JSR	— 050 —	6L	/									

Model	
JSR	High Purity Gas Pressure Reducing Valve

Size	
050	1/2"
075	3/4"

Material	
6L	Stainless Steel 316L

1	Body Feature
End Connection	
ASME BPE Selections	
C	Tri-Clamp 20 Ra EP
P	FNPT 20 Ra EP
T	Tube Weld End 20 Ra EP
ISO Selections	
S ¹	ISO Tri-Clamp, DN15
V ¹	ISO w/34.0mm face T-Clamp, DN15
R ¹	ISO T-Clamp, DN20
H ⁴	ISO Tube Weld, DN15
DIN Selections	
D ²	DIN Tri-Clamp, DN15
N ²	DIN T-Clamp, DN15 w/50.5mm face
U ²	DIN T-Clamp, DN20
X ²	DIN T-Clamp, DN20 w/50.5mm face
M ³	DIN Tube Weld, DN15
ZZ	Non-Standard

2	Body Feature
Port Configuration*	
A	Port "A"
B	Port "B"
C	Port "C"
D	Port "D"
E	Port "E"

* Std. Gauge Ports are 1/4" FNPT. Contact factory for availability of others

7 & 8	Range Spring/Outlet Pressure
05	5 - 70 PSI
0B	15 - 90 PSI
50	50 - 125 PSI
ZZ	Non-Standard

9 & 10	Diaphragm Material
JL	Jorlon
ZZ	Non-Standard

11 & 12	Actuator
SK	Standard Actuator
AK	Standard Actuator / Autoclavable Anod. Aluminum knob
PM	Panel Mount
CV ¹	Captured Vent provides fitting on spring housing for venting self-relieved gas
AA ¹	Air Loading provides fitting for air input on spring housing, and a stem seat nut
TP	Anti-tamper feature (See illustration page 4)
ZZ	Non-Standard

¹ See page 3 for complete description

13 & 14	Inlet Gauge*
ØB	0 - 30 PSIG/Bar (Dual)
ØC	0 - 60 PSIG/Bar (Dual)
ØD	0 - 100 PSIG/Bar (Dual)
ØE	0 - 160 PSIG/Bar (Dual)
ØF	0 - 200 PSIG/Bar (Dual)
ØN	None
ZZ	Non-Standard

* Customer assumes all responsibility for possible damage or injury if selected gauge span does not fully cover range spring / outlet pressure option

15	Outlet Gauge*
B	0 - 30 PSIG/Bar (Dual)
C	0 - 60 PSIG/Bar (Dual)
D	0 - 100 PSIG/Bar (Dual)
E	0-160 PSIG/Bar (Dual)
N	None
ZZ	Non-Standard

* Customer assumes all responsibility for possible damage or injury if selected gauge span does not fully cover range spring / outlet pressure option

¹ Acc. to DIN 32676 Row B (ISO 1127). See dimensions, page 3

² Acc. to DIN 32676 Row A. See dimensions, page 3

³ Acc. to DIN 11866, DIN 11850 Row A

⁴ Acc. to DIN 11866 Row B

3 & 4	Trim
1S	0.8 Cv
2S	0.5 Cv
1R	CV 0.8 Self-Relieving*
2R	Cv 0.5 Self-Relieving*
ZZ	Non-Standard

* You cannot choose the Self-Relieving option, if using the Capture Vent option for Air-Loading. See Page 3 for complete description.

5 & 6	Seat Material
TF	PTFE
PK	Peek
EP	EPDM
ZZ	Non-Standard

16	SEP Compliance
0	None Required
G	SEP Compliant
Z	Non-Standard

...continued on next page

17	Accessories
0	None Required
S	Clean For Oil Free
X	Clean for Oxygen ²
J	Clean for Oxygen, Assemble Dry ^{1,2}
A	EN10204 3.1 Cert for Wetted Parts
Z	Non-Standard

¹ Procedure complies with ASTM G-93 2011 and CGA G-4.1-2009

² Use of Oxygen safe lubricant (Krytox™ for example) can affect gas line particulate testing. Assembling all wetted components dry (without lubricant) removes that effect, however it may increase the difficulty in disassembly/reassembly of valve seat components during valve maintenance. Note that we will use O2 safe lubricant on non-wetted threaded components.

REPAIR KIT ORDERING SCHEMATIC

Model		Size		Material		Kit		1&2	3&4
JSR	-	050	-	6L	-	Kit	/	1P	SJ

Model	
	High Purity Gas Pressure Reducing Valve

Size	
050	1/2"
075	3/4"

Material	
6L	Stainless Steel 316L

Kit	
Kit	Repair Kit

1 & 2	Trim/Seat Material
1P	Cv 0.8/PEEK
1T	Cv 0.8/PTFE
1E	Cv 0.8/EPDM
2P	Cv 0.5/PEEK
2T	Cv 0.5/PTFE
2E	Cv 0.5/EPDM
ZZ	Non-Standard

3 & 4	Diaphragm Assembly
RJ	Self Relieving/Jorlon
SJ	Standard/Jorlon
ZZ	Non-Standard